



LIGHTING FIXTURES FOR EXTREME AMBIENT TEMPERATURES



PITBUL-EX-LED

-20°C to +55/60°C

Linear_Aluminum/Glass



FILA-N-LED

-20°C to +55/60°C

Linear_Metal/304SS/Glass



BERGER-N-LED

-40°C to +60°C

HighBay_Aluminum/Glass



EXTRA-N-LED

-20°C to +60°C

Linear_PC



SALUKA-N-LED

-20°C to +60°C

Linear_Metal/304SS/Glass



PITBUL-N-LED

-20°C to +55/65°C

Linear_Metal/304SS/Glass



NORD-N-LED-OPG

-20°C to +60°C

Recessed_Metal/304SS/Glass



NORD-N-LED-CG

-20°C to +60°C

Recessed_Metal/304SS/Glass



EXTRA-LED-PLUS/FROST
-40°C to +60/65/70°C
Linear_PC



SALUKA-LED-PLUS/FROST
-40°C to +70°C
Linear_Metal/304SS/Glass



EXTREME-LED-PLUS/FROST
-40°C to +65/70/75°C
Linear_Metal/PC/Glass



PITBUL-LED-PLUS
-20°C to +60°C
Linear_Metal/304SS/Glass



GALGO-LED(-FF)
-20°C to +60°C
Linear_Metal/304SS/PC
FF: Anti-Ligature



PITBUL-Ex-LED

IP 65 / zone 1, 21

5 year warranty

SILICONE FREE



IK10 (5kg@40cm)



FTZÚ 16 ATEX 0089X



Application: The dustproof lighting fixture PITBUL-Ex-LED with splash water resistance is designed for lighting of areas with danger of explosion. The lighting fixture is certified by FTZU Ostrava-Radvanice (certificate type FTZU 16 ATEX 0089X).

Ballast: EP – electronic 110 – 254 V, 50/60 Hz, 220 – 250 V, 0 Hz DC

Light source: LED, 4000K, CRI +80

Housing: White painted steel sheet RAL 9003

Diffuser: Opal hardened safety glass with HST test

Fastening: Direct surface wal or ceiling mounting via M8 screws through the base, with ceiling brackets or adjustable brackets, suspension via suspension brackets, into false ceiling by means of recessed frame, on the pole with set of pole brackets.

Connection: Screwless three-pole terminal block, maximum diameter of wires 4 mm²

Standard equipment: 1pc EX plastic cable gland M20x1,5 for diameter of cable 7-12mm, 1pc EX plastic sealing plug

Calculated lifetime – LED modules:
 L80B50 ta55°C - 50 000h - 418/436
 L80B50 ta 60°C - 50 000h - 218/236

PITBUL-Ex-LED	PITBUL-Ex-LED-WOD
Ⓜ II 2G Ex db eb mb op is IIC T4 Gb	Ⓜ II 2G Ex eb mb op is IIC T4 Gb
Ⓜ II 2D Ex tb op is IIIC T67°C Db	Ⓜ II 2D Ex tb op is IIIC T67°C Db

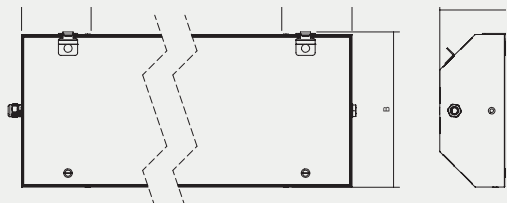

Order number	Name	Lighting fixture luminous flux (lm)	Power input (W)	Rated power output (lm/W)	Ta max (°C)	Dimensions of lighting fixture A x B x C (mm)	Mounting spacing D (mm)	Equivalent*	Weight (kg)
version with disconnecter - lighting fixtures suitable for ambient temperatures -20°C									
053684	PITBUL-Ex-LED-OP-D-2750-218-4K	2377	16	149	60	703x310x142	450	3x18W	7,7
053700	PITBUL-Ex-LED-OP-D-4000-218-4K	3373	30	112	60	703x310x142	450	4x18W	7,7
053685	PITBUL-Ex-LED-OP-D-5500-418-4K	4695	30	157	55	703x369x142	450	2x36W	10,3
053701	PITBUL-Ex-LED-OP-D-8000-418-4K	6663	51	131	55	703x369x142	450	X	10,3
053686	PITBUL-Ex-LED-OP-D-5500-236-4K	4784	30	159	60	1313x310x142	800	X	15,1
053702	PITBUL-Ex-LED-OP-D-8000-236-4K	6742	53	127	60	1313x310x142	800	2x58W/3x36W	15,1
053687	PITBUL-Ex-LED-OP-D-11000-436-4K	9546	60	159	55	1313x369x142	800	3x58W	19,4
053703	PITBUL-Ex-LED-OP-D-16000-436-4K	13447	102	132	55	1313x369x142	800	4x58W	19,4
version without disconnecter - lighting fixtures suitable for ambient temperatures -20°C									
053680	PITBUL-Ex-LED-OP-WOD-2750-218-4K	2377	16	149	60	703x310x142	450	3x18W	7,7
053696	PITBUL-Ex-LED-OP-WOD-4000-218-4K	3373	30	112	60	703x310x142	450	4x18W	7,7
053681	PITBUL-Ex-LED-OP-WOD-5500-418-4K	4695	30	157	55	703x369x142	450	2x36W	10,3
053697	PITBUL-Ex-LED-OP-WOD-8000-418-4K	6663	51	131	55	703x369x142	450	X	10,3
053682	PITBUL-Ex-LED-OP-WOD-5500-236-4K	4784	30	159	60	1313x310x142	800	X	15,1
053698	PITBUL-Ex-LED-OP-WOD-8000-236-4K	6742	53	127	60	1313x310x142	800	2x58W/3x36W	15,1
053683	PITBUL-Ex-LED-OP-WOD-11000-436-4K	9546	60	159	55	1313x369x142	800	3x58W	19,4
053699	PITBUL-Ex-LED-OP-WOD-16000-436-4K	13447	102	132	55	1313x369x142	800	4x58W	19,4

Tolerance of luminous flux and power input of the lighting fixture +/- 10%
 * Luminaires are not a direct replacement. They may vary in length. The required lighting of the room must be verified by calculation.

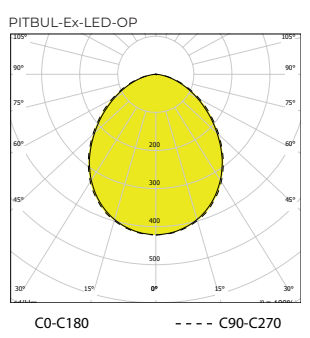

SAFE answers to HAZARDOUS questions

Order number	Name	Lighting fixture luminous flux (lm)	Power input (W)	Rated power output (lm/W)	Ta min (°C)	Dimensions of lighting fixture A x B x C (mm)	Mounting spacing D (mm)	Weight (kg)
version FROST - lighting fixtures suitable for ambient temperatures -40°C								
053690	PITBUL-Ex-LED-OP-FROST-WOD-4000-218-4K	3373	30	112	-40	703x310x142	450	10,3
053691	PITBUL-Ex-LED-OP-FROST-WOD-8000-418-4K	6663	51	131	-40	703x369x142	450	10,3
053692	PITBUL-Ex-LED-OP-FROST-WOD-8000-236-4K	6742	53	127	-40	1313x310x142	800	15,1
053693	PITBUL-Ex-LED-OP-FROST-WOD-16000-436-4K	13447	102	132	-40	1313x369x142	800	19,4

Accessories on request

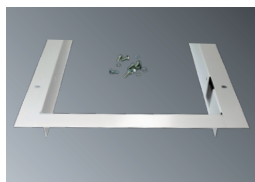

- 053941 Set of recessed frame PITBUL 1x-3x18W
- 053942 Set of recessed frame PITBUL 4x18W
- 053943 Set of recessed frame PITBUL 1x-3x36W
- 053944 Set of recessed frame PITBUL 4x36W
- 053945 Set of recessed frame PITBUL 1x-3x58W
- 053946 Set of recessed frame PITBUL 4x58W



- 054935 Set of stainless steel ceiling brackets PITBUL (2 pcs)



- 053940 Set of adjustable brackets PITBUL



- 004642 Suspension bracket DIN 580 M8 - 1 pc



- 051146 Pole bracket PITBUL (for Ø 50 mm)

Accessories for armoured cable M20

- 008052 Cable gland BIMED M20x1.5 ORION UNIVERSAL (8+/- 0.5Nm)
- 008091 Sealing plug WISKA EMVS20 M20x1.5 Ex-nickel-plated brass
- 008093 Nut WISKA EMMU20 M20x1.5 - nickel-plated brass
- 007047N Flat sealing ring EPDM 27x18.5x1.5 mm

On request

EM-1.5/3 - non-maintained emergency lighting

1/3 F - single-phase or three phase through wiring connection, maximum diameter of wires 4 mm²

MULTI-1.5/3 - maintained emergency lighting

RAL - another colour scale

NEREZ - body from stainless steel AISI 304 or AISI 316

(in case of STAINLESS STEEL version its declared for ambient temperature decreased about 5-10°C)

3000/4000/6000K - colour temperature

Standard order number	MULTI-1,5H	MULTI-3H	DALI	1F	3F	EM	
053684	X	X	X	053684 1F	053684 3F	053712	PITBUL-Ex-Em-LED-OP-600-218-4K
053700	053708	053704	X	053700 1F	053700 3F	053713	PITBUL-Ex-Em-LED-OP-900-236-4K
053685	X	X	X	053685 1F	053685 3F	053714	PITBUL-Ex-Em-LED-OP-400-218-4K
053701	053709	053705	X	053701 1F	053701 3F	053715	PITBUL-Ex-Em-LED-OP-500-236-4K
053686	X	X	X	053686 1F	053686 3F		
053702	053710	053706	X	053702 1F	053702 3F		
053687	X	X	X	053687 1F	053687 3F		
053703	053711	053707	X	053703 1F	053703 3F		
053680	X	X	X	053680 1F	053680 3F		
053696	X	X	X	053696 1F	053696 3F		
053681	X	X	X	053681 1F	053681 3F		
053697	X	X	X	053697 1F	053697 3F		
053682	X	X	X	053682 1F	053682 3F		
053698	X	X	X	053698 1F	053698 3F		
053683	X	X	X	053683 1F	053683 3F		
053699	X	X	X	053699 1F	053699 3F		

Use of lighting fixtures in areas with danger of explosion	Marking of external influences	Area classification	
		Marking	Directive
Danger of explosion of flammable dust	BE3N1	ZONE 21.22	ČSN EN 60079-14, ČSN EN 60079-10-2
Danger of explosion of flammable gases and vapours	BE3N2	ZONE 1.2	ČSN EN 60079-14, ČSN EN 60079-10-1



FILA-N-LED

IP 66 / zone 2, 21 / 2, 22

5 year warranty

SILICONE FREE

FTZÚ 20 ATEX 0075X, FTZÚ 20 ATEX 0077X



Application: The dustproof recessed lighting fixture FILA-N-LED with splash water resistance designed for lighting of areas with danger of explosion. They can be used mainly in paint cabins and paint workshops. The lighting fixture is approved by FTZÚ Ostrava - Radvanice (certificate type FTZÚ 20 ATEX 0075X a FTZÚ 20 ATEX 0077X).

Ballast: EP – electronic 220-240V/50-60Hz AC, EVG – electronic 220-240V, 0 Hz DC

Light Light source: LED, 4000K, CRI +80, MacAdam3

Housing: Painted steel sheet RAL 9003

Cover: OP – opal tempered safety glass

Reflector: Painted steel sheet RAL 9003

Fastening: Recessed ceiling mounting or surface mounting using a mounting frame

Connection: Screwed connecting terminal block, maximum cable cross section 2.5 mm²

Standard equipment: 2 pcs EX M20 cable glands for diameter of cable 7-12mm and 3 pcs EX M20 sealing plug

Calculated life time of LED modules: L80B10 ta35 – 70 000 h
L70B10 ta35 – 100 000 h

FILA-N-LED zone 2, 21

- II 3G Ex nR IIC T6 Gc
- 2D Ex tb op is IIIC T70°C Db

FILA-N-LED zone 2, 22

- II 3G Ex nR IIC T6 Gc
- II 3D Ex tc IIIC T70°C Dc

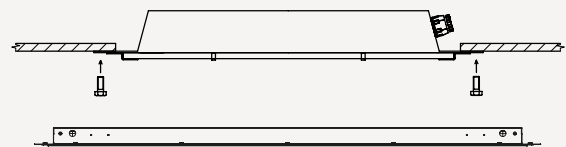
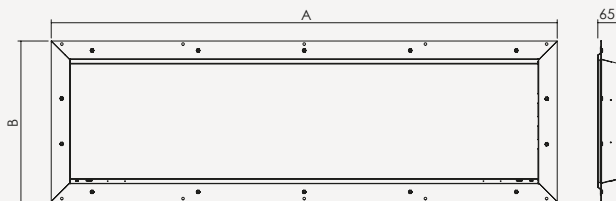

Order number	Name	Lighting fixture luminous flux (lm)	Power input (W)	System efficiency (lm/W)	Ta max (°C)	Lighting fixture dimensions A x B x C (mm)	Mounting hole (mm)	Weight (kg)
2, 21								
050500	FILA-N-LED-2,21-OP-5000-218-4K	4372	33	132	65	770x380x65	720x335	9,5
050501	FILA-N-LED-2,21-OP-10000-418-4K	8847	66	134	50	770x530x65	720x485	16,3
050502	FILA-N-LED-2,21-OP-10000-236-4K	9362	66	142	50	1370x380x65	1320x335	20,9
050503	FILA-N-LED-2,21-OP-18300-436-4K	16354	117	140	45	1370x530x65	1320x485	13,4
050504	FILA-N-LED-2,21-OP-15000-258-4K	13580	101	134	45	1670x380x65	1620x335	22,4
050505	FILA-N-LED-2,21-OP-29000-458-4K	25692	188	137	40	1670x530x65	1620x485	27,7

Tolerance of luminous flux and power input of the lighting fixture +/- 10%

FILA-N-LED-OP

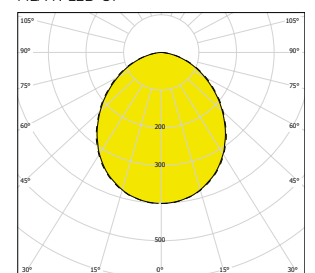

SAFE answers to HAZARDOUS questions

Variants of lighting fixture



STANDARD



050500	FILA-N-LED-2,21-OP-5000-218-4K
050501	FILA-N-LED-2,21-OP-10000-418-4K
050502	FILA-N-LED-2,21-OP-10000-236-4K
050503	FILA-N-LED-2,21-OP-18300-436-4K
050504	FILA-N-LED-2,21-OP-15000-258-4K
050505	FILA-N-LED-2,21-OP-29000-458-4K



CORNER



050530	FILA-N-LED-2,21-OP-CORNER-10000-236-4K
050533	FILA-N-LED-2,21-OP-CORNER-15000-258-4K
050536	FILA-N-LED-2,21-OP-CORNER-29000-458-4K



DIAGONAL



050531	FILA-N-LED-2,21-OP-DIAGONAL-10000-236-4K
050534	FILA-N-LED-2,21-OP-DIAGONAL-15000-258-4K
050537	FILA-N-LED-2,21-OP-DIAGONAL-29000-458-4K



SURFACE



050532	FILA-N-LED-2,21-OP-SURFACE-10000-236-4K
050535	FILA-N-LED-2,21-OP-SURFACE-15000-258-4K
050538	FILA-N-LED-2,21-OP-SURFACE-29000-458-4K



SURFACE VERTICAL



050539	FILA-N-LED-2,21-OP-SURFACE-VERTICAL-15000-258-4K
050541	FILA-N-LED-2,21-OP-SURFACE-VERTICAL-10000-236-4K



SURFACE HORIZONTAL



050540	FILA-N-LED-2,21-OP-SURFACE-HORIZONTAL-15000-258-4K
050542	FILA-N-LED-2,21-OP-SURFACE-HORIZONTAL-10000-236-4K

On request

DIM – dimmable electronic ballast (DALI)

2.7K-6.5K - colour temperature

MULTI-1.5h/3h - maintained emergency lighting

EM-1.5h/3h - non-maintained emergency lighting

RAL - other colour scale

NANO - lighting fixtures can be protected by special nano-layer (hydrophobic, oleophobic or antibacterial protection)

NEREZ - housing produced from stainless steel AISI 304 or AISI 316

(in case of STAINLESS STEEL version its declared for ambient temperature decreased about 5-10°C)

1/3 F - single-phase or three phase through wiring connection, maximum diameter of wires 2.5mm²

SURFACE VERTICAL - surface mounted, bevelled vertical wall

SURFACE HORIZONTAL - surface mounted, bevelled horizontal wall

CORNER - corner installation

DIAGONAL - installation under angle

Standard order number	MULTI-1H	MULTI-3H	DALI	1F	3F
050500	050510	050516	050500 DALI	050500 1F	050500 3F
050502	050512	050518	050502 DALI	050502 1F	050502 3F
050504	050514	050520	050504 DALI	050504 1F	050504 3F
050501	050511	050517	050501 DALI	050501 1F	050501 3F
050503	050513	050519	050503 DALI	050503 1F	050503 3F
050505	050515	050521	050505 DALI	050505 1F	050505 3F

Use of lighting fixtures in areas with danger of explosion	Marking of external influences	Area classification	
		Marking	Directive
Danger of explosion of flammable dusts	BE3N1	ZONE 21,22	ČSN EN 60079-14, ČSN EN 60079-10-2
Danger of explosion of flammable gases and vapours	BE3N2	ZONE 2	ČSN EN 60079-14, ČSN EN 60079-10-1

STL International Ltd

Hill Farm, Linton Hill, Maidstone, Kent, ME17 4AL, UK T. +44 (0)1622 749633 eMail. solutions@stl-int.co.uk Web. www.stl-int.co.uk



BERGER-N-LED

IP66 / Ex ZONE 2/21, 22

5 year warranty

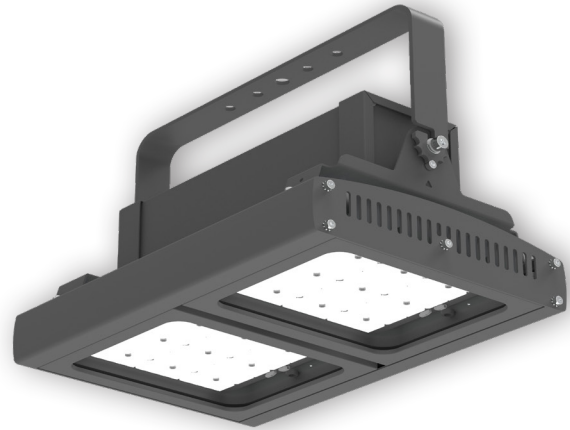

Application: Robust explosion-proof **HIGH-BAY LED luminaire** designed for lighting of hazardous areas **ATEX ZONE 2/21, 22**. Housing made of extremely durable aluminium (RAL7043). Cover made of clear tempered safety glass. Optic system inside guarantees various lumen curves for different applications. High quality electronic components guarantee **high efficiency up to 167 lm/W and extremely long lifetime 100 000 h even at high temperatures**. **Modular system** allows to choose the luminous output according to project needs. **Dust and water proof with a rating IP66**. It can be operated at temperatures **from -40°C to +60°C**. Excellent heat dissipation due to additional cooling of each luminaire module. For suspended or surface mounting. Adjustable bracket allows a wide variety of applications.

Ballast: EP – electronic - 220–240 V, 50/60 Hz

Light source: LED, 4000 K, CRI +80, MacAdam3

Housing: Aluminium profile RAL 7043

Diffuser: Clear tempered safety glass

Fastening: Suspended by means of brackets or surface mounted by means of adjustable bracket (adjustable bracket on request only) **Connection:** By means of 2 m cable. T50/T60 versions are as standard equipped with plastic cable gland

Standard equipment: 4x stainless steel suspending eye-bolts (M5), 2 m cable (3x1,5 mm²)

Calculated life time of LED modules: L90B50 Ta25 – 50 000 h; L80B50 Ta25 – 150 000 h; L70B50 Ta60 – 100 000 h

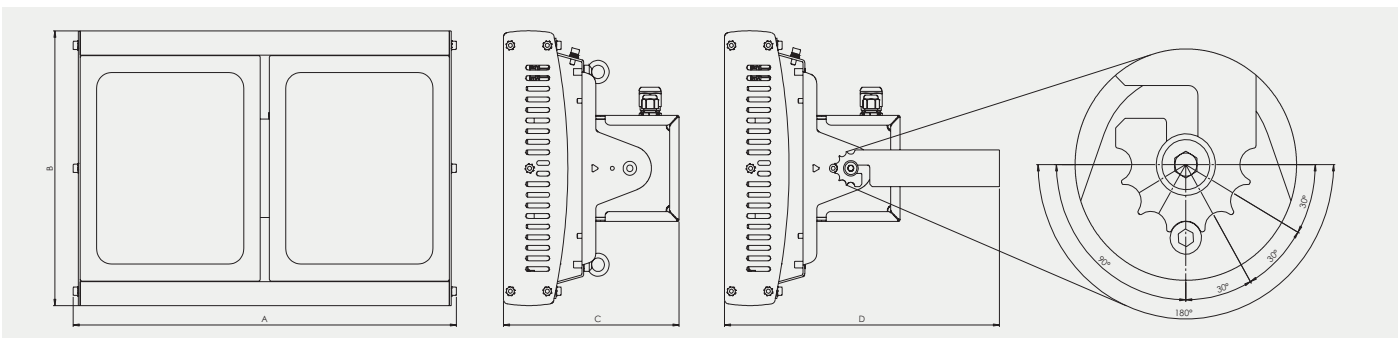
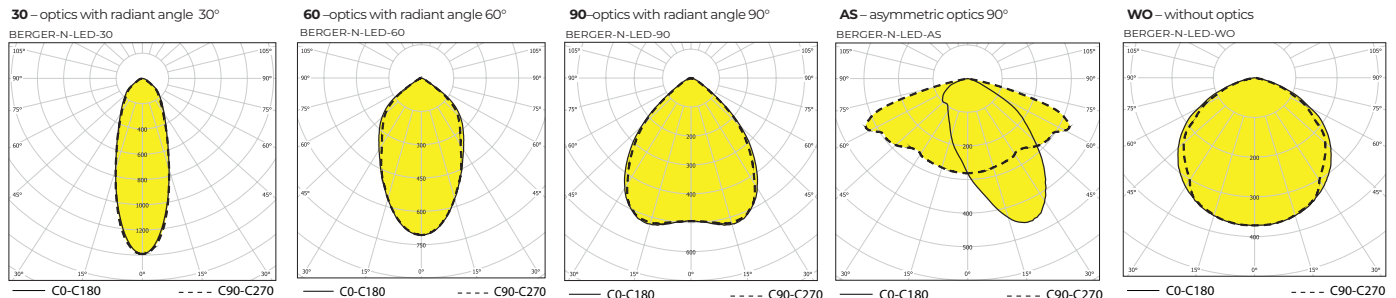

ADVANTAGES:

- Extreme high led lifetime L70B50 Ta60 - 100 000 h even at high temperatures
- Made in Europe - Czech Republic origin
- ATEX certification ZONE 2/21, 22
- Robust housing
- High efficiency up to 167 lm/W
- Luminous flux versions from 8 000 up to 43 000 lm
- Option of adjustable installation
- Variability of declared ambient temperatures

BERGER-N-LED ZONE 2/21
(FTZÚ 22 ATEX 0107X)

- Ⓜ II 3G Ex nR IIC T6...T5 Gc
- Ⓜ II 2D Ex tb op is IIIC T85°C Db

BERGER-N-LED ZONE 2/22
(FTZÚ 22 ATEX 0108X)

- Ⓜ II 3G Ex nR IIC T6...T5 Gc
- Ⓜ II 3D Ex tc IIIC T85°C Dc

TYPICAL APPLICATION:

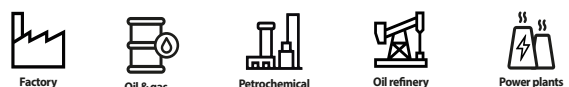

Order number	Name	Lighting fixture luminous flux (lm)	Power input (W)	Rated power output (lm/W)	Ta (°C)	Dimensions of lighting fixture A x B x C (mm)	T-class	Nr. LED modules	Weight (Kg)
Ta 50°C									
080848	BERGER-N-LED-2,21-T50-30-12200-4K-1M, IP66	10031	69	145	-20°C/50°C	415x285x190	T6	1	8,5
080800	BERGER-N-LED-2,21-T50-60-12200-4K-1M, IP66	10767	69	156	-20°C/50°C	415x285x190	T6	1	8,5
080801	BERGER-N-LED-2,21-T50-90-12200-4K-1M, IP66	10922	69	158	-20°C/50°C	415x285x190	T6	1	8,5
080849	BERGER-N-LED-2,21-T50-AS-12200-4K-1M, IP66	9700	69	141	-20°C/50°C	415x285x190	T6	1	8,5
080802	BERGER-N-LED-2,21-T50-WO-12200-4K-1M, IP66	10566	69	153	-20°C/50°C	415x285x190	T6	1	8,5
Ta 60°C									
080856	BERGER-N-LED-2,21-T60-30-9900-4K-1M, IP66	8220	54	152	-20°C/60°C	415x285x190	T5	1	8,5
080812	BERGER-N-LED-2,21-T60-60-9900-4K-1M, IP66	8799	54	163	-20°C/60°C	415x285x190	T5	1	8,5
080813	BERGER-N-LED-2,21-T60-90-9900-4K-1M, IP66	8933	54	165	-20°C/60°C	415x285x190	T5	1	8,5
080857	BERGER-N-LED-2,21-T60-AS-9900-4K-1M, IP66	7948	54	147	-20°C/60°C	415x285x190	T5	1	8,5
080814	BERGER-N-LED-2,21-T60-WO-9900-4K-1M, IP66	8622	54	160	-20°C/60°C	415x285x190	T5	1	8,5
Ta -40°C									
080872	BERGER-N-LED-2,21-FROST-30-9900-4K-1M, IP66	8220	54	152	-40°C/50°C	415x285x190	T6	1	8,5
080836	BERGER-N-LED-2,21-FROST-60-9900-4K-1M, IP66	8799	54	163	-40°C/50°C	415x285x190	T6	1	8,5
080837	BERGER-N-LED-2,21-FROST-90-9900-4K-1M, IP66	8933	54	165	-40°C/50°C	415x285x190	T6	1	8,5
080873	BERGER-N-LED-2,21-FROST-AS-9900-4K-1M, IP66	7948	54	147	-40°C/50°C	415x285x190	T6	1	8,5
080838	BERGER-N-LED-2,21-FROST-WO-9900-4K-1M, IP66	8622	54	160	-40°C/50°C	415x285x190	T6	1	8,5

1M - 1 module

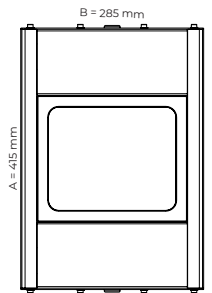

Order number	Name	Lighting fixture luminous flux (lm)	Power input (W)	Rated power output (lm/W)	Ta (°C)	Dimensions of lighting fixture A x B x C (mm)	T-class	Nr. LED modules	Weight (Kg)
Ta 50°C									
080850	BERGER-N-LED-2,21-T50-30-24400-4K-2M, IP66	20061	136	148	-20°C/50°C	415x285x190	T6	2	11
080803	BERGER-N-LED-2,21-T50-60-24400-4K-2M, IP66	21534	136	158	-20°C/50°C	415x285x190	T6	2	11
080804	BERGER-N-LED-2,21-T50-90-24400-4K-2M, IP66	21844	136	161	-20°C/50°C	415x285x190	T6	2	11
080851	BERGER-N-LED-2,21-T50-AS-24400-4K-2M, IP66	19399	136	143	-20°C/50°C	415x285x190	T6	2	11
080805	BERGER-N-LED-2,21-T50-WO-24400-4K-2M, IP66	21132	136	155	-20°C/50°C	415x285x190	T6	2	11
Ta 60°C									
080858	BERGER-N-LED-2,21-T60-30-19800-4K-2M, IP66	16439	107	154	-20°C/60°C	415x285x190	T5	2	11
080815	BERGER-N-LED-2,21-T60-60-19800-4K-2M, IP66	17597	107	164	-20°C/60°C	415x285x190	T5	2	11
080816	BERGER-N-LED-2,21-T60-90-19800-4K-2M, IP66	17866	107	167	-20°C/60°C	415x285x190	T5	2	11
080859	BERGER-N-LED-2,21-T60-AS-19800-4K-2M, IP66	15895	107	149	-20°C/60°C	415x285x190	T5	2	11
080817	BERGER-N-LED-2,21-T60-WO-19800-4K-2M, IP66	17243	107	161	-20°C/60°C	415x285x190	T5	2	11
Ta -40°C									
080874	BERGER-N-LED-2,21-FROST-30-19800-4K-2M, IP66	16439	107	154	-40°C/50°C	415x285x190	T6	2	11
080839	BERGER-N-LED-2,21-FROST-60-19800-4K-2M, IP66	17597	107	164	-40°C/50°C	415x285x190	T6	2	11
080840	BERGER-N-LED-2,21-FROST-90-19800-4K-2M, IP66	17866	107	167	-40°C/50°C	415x285x190	T6	2	11
080875	BERGER-N-LED-2,21-FROST-AS-19800-4K-2M, IP66	15895	107	149	-40°C/50°C	415x285x190	T6	2	11
080841	BERGER-N-LED-2,21-FROST-WO-19800-4K-2M, IP66	17243	107	161	-40°C/50°C	415x285x190	T6	2	11

2M - 2 modules

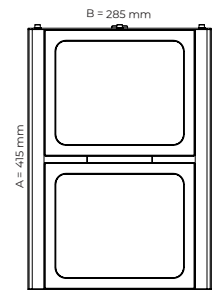

Order number	Name	Lighting fixture luminous flux (lm)	Power input (W)	Rated power output (lm/W)	Ta (°C)	Dimensions of lighting fixture A x B x C (mm)	T-class	Nr. LED modules	Weight (Kg)
Ta 50°C									
080852	BERGER-N-LED-2,21-T50-30-36600-4K-3M, IP66	29812	204	146	-20°C/50°C	620x285x190	T6	3	14
080806	BERGER-N-LED-2,21-T50-60-36600-4K-3M, IP66	32252	204	158	-20°C/50°C	620x285x190	T6	3	14
080807	BERGER-N-LED-2,21-T50-90-36600-4K-3M, IP66	32726	204	160	-20°C/50°C	620x285x190	T6	3	14
080853	BERGER-N-LED-2,21-T50-AS-36600-4K-3M, IP66	29159	204	143	-20°C/50°C	620x285x190	T6	3	14
080808	BERGER-N-LED-2,21-T50-WO-36600-4K-3M, IP66	31659	204	155	-20°C/50°C	620x285x190	T6	3	14
Ta 60°C									
080860	BERGER-N-LED-2,21-T60-30-26200-4K-3M, IP66	21603	144	150	-20°C/60°C	620x285x190	T5	3	14
080818	BERGER-N-LED-2,21-T60-60-26200-4K-3M, IP66	23408	144	163	-20°C/60°C	620x285x190	T5	3	14
080819	BERGER-N-LED-2,21-T60-90-26200-4K-3M, IP66	23622	144	164	-20°C/60°C	620x285x190	T5	3	14
080861	BERGER-N-LED-2,21-T60-AS-26200-4K-3M, IP66	21060	144	146	-20°C/60°C	620x285x190	T5	3	14
080820	BERGER-N-LED-2,21-T60-WO-26200-4K-3M, IP66	22899	144	159	-20°C/60°C	620x285x190	T5	3	14

3M - 3 modules

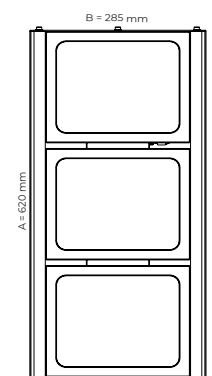

Order number	Name	Lighting fixture luminous flux (lm)	Power input (W)	Rated power output (lm/W)	Ta (°C)	Dimensions of lighting fixture A x B x C (mm)	T-class	Nr. LED modules	Weight (Kg)
Ta -40°C									
080876	BERGER-N-LED-2,21-FROST-30-26200-4K-3M, IP66	21603	144	150	-40°C/50°C	620x285x190	T6	3	14
080842	BERGER-N-LED-2,21-FROST-60-26200-4K-3M, IP66	23408	144	163	-40°C/50°C	620x285x190	T6	3	14
080843	BERGER-N-LED-2,21-FROST-90-26200-4K-3M, IP66	23622	144	164	-40°C/50°C	620x285x190	T6	3	14
080877	BERGER-N-LED-2,21-FROST-AS-26200-4K-3M, IP66	21060	144	146	-40°C/50°C	620x285x190	T6	3	14
080844	BERGER-N-LED-2,21-FROST-WO-26200-4K-3M, IP66	22899	144	159	-40°C/50°C	620x285x190	T6	3	14

Order number	Name	Lighting fixture luminous flux (lm)	Power input (W)	Rated power output (lm/W)	Ta (°C)	Dimensions of lighting fixture A x B x C (mm)	T-class	Nr. LED modules	Weight (Kg)
Ta 40°C									
080854	BERGER-N-LED-2,21-T40-30-48800-4K-4M, IP66	39749	287	138	-20°C/40°C	825x285x190	T6	4	17
080809	BERGER-N-LED-2,21-T40-60-48800-4K-4M, IP66	43002	287	150	-20°C/40°C	825x285x190	T6	4	17
080810	BERGER-N-LED-2,21-T40-90-48800-4K-4M, IP66	43634	287	152	-20°C/40°C	825x285x190	T6	4	17
080855	BERGER-N-LED-2,21-T40-AS-48800-4K-4M, IP66	38879	287	135	-20°C/40°C	825x285x190	T6	4	17
080811	BERGER-N-LED-2,21-T40-WO-48800-4K-4M, IP66	42212	287	147	-20°C/40°C	825x285x190	T6	4	17
Ta 60°C									
080862	BERGER-N-LED-2,21-T60-30-30200-4K-4M, IP66	24897	163	153	-20°C/60°C	825x285x190	T5	4	17
080821	BERGER-N-LED-2,21-T60-60-30200-4K-4M, IP66	26977	163	166	-20°C/60°C	825x285x190	T5	4	17
080822	BERGER-N-LED-2,21-T60-90-30200-4K-4M, IP66	27224	163	167	-20°C/60°C	825x285x190	T5	4	17
080863	BERGER-N-LED-2,21-T60-AS-30200-4K-4M, IP66	24271	163	149	-20°C/60°C	825x285x190	T5	4	17
080823	BERGER-N-LED-2,21-T60-WO-30200-4K-4M, IP66	26391	163	162	-20°C/60°C	825x285x190	T5	4	17
Ta -40°C									
080878	BERGER-N-LED-2,21-FROST-30-30200-4K-4M, IP66	24897	163	153	-40°C/50°C	825x285x190	T6	4	17
080845	BERGER-N-LED-2,21-FROST-60-30200-4K-4M, IP66	26977	163	166	-40°C/50°C	825x285x190	T6	4	17
080846	BERGER-N-LED-2,21-FROST-90-30200-4K-4M, IP66	27224	163	167	-40°C/50°C	825x285x190	T6	4	17
080879	BERGER-N-LED-2,21-FROST-AS-30200-4K-4M, IP66	24271	163	149	-40°C/50°C	825x285x190	T6	4	17
080847	BERGER-N-LED-2,21-FROST-WO-30200-4K-4M, IP66	26391	163	162	-40°C/50°C	825x285x190	T6	4	17

4M - 4 modules

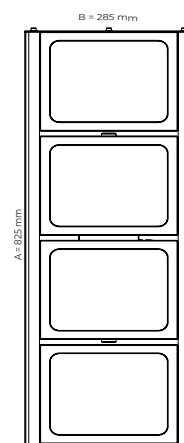

Accessories on request

051229 - Adjustable wall mounting bracket BERGER

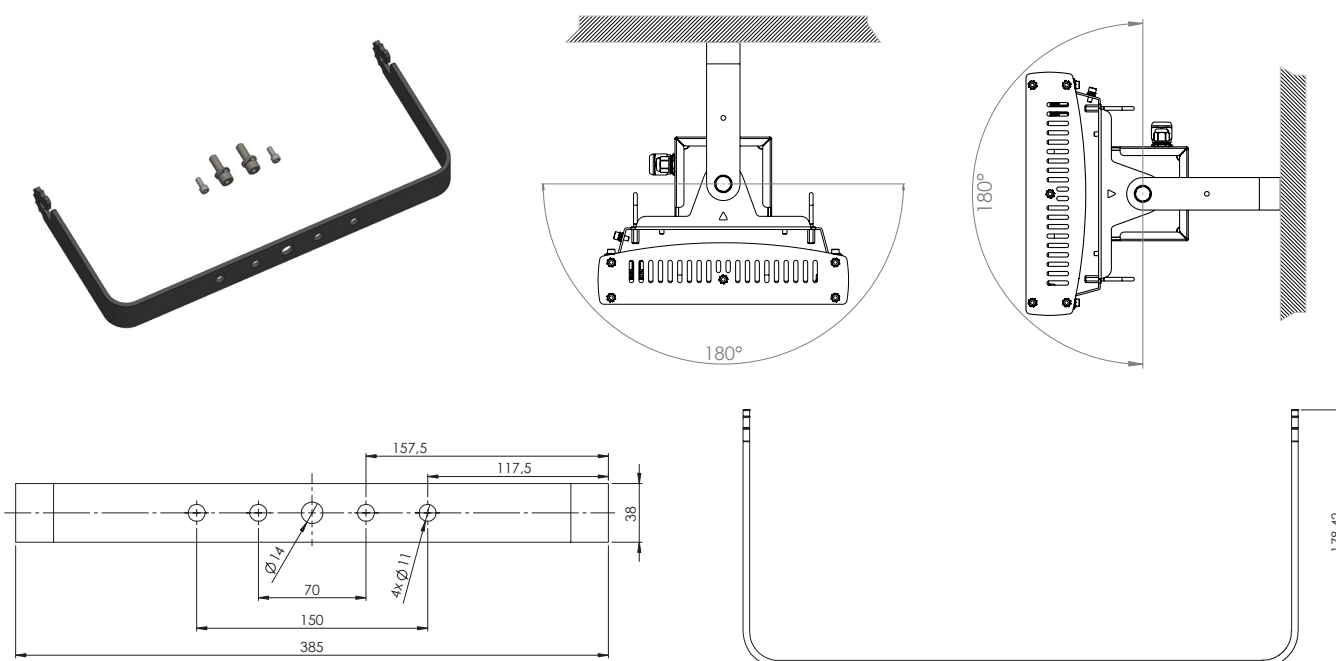

Light fixture variants according to the number of modules

1M - 1 module

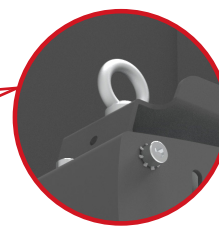
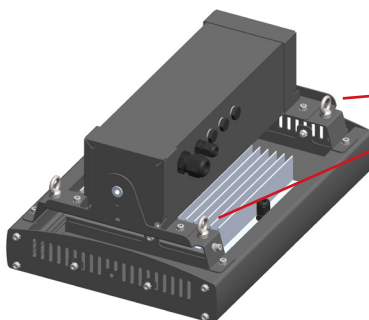

Standard equipment stainless steel eye-bolt

2M - 2 modules

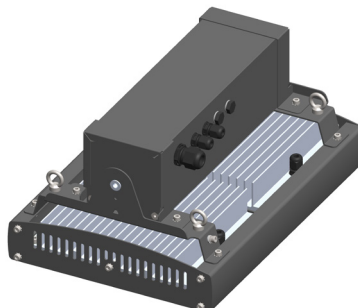

3M - 3 modules

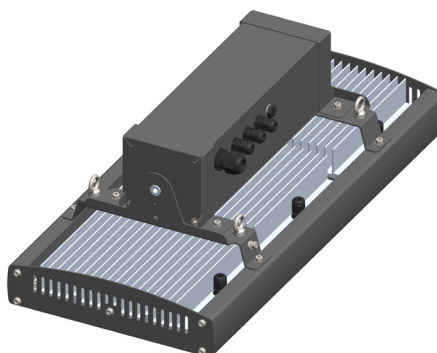
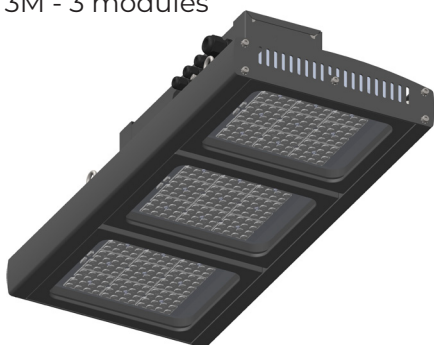

4M - 4 modules

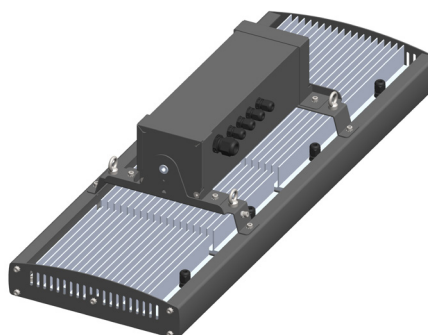

On request

DIM – dimmable electronic ballast (DALI)

2700 K/3000 K/4000 K/5000 K/5700 K/6500 K - colour temperature

MULTI – 3 hour maintained emergency

Use of lighting fixtures in areas with danger of explosion	Marking of external influences	Area classification	
		Marking	Directive
Danger of explosion of flammable dust	BE3N1	ZONE 21, 22	ČSN EN 60079-14, ČSN EN 60079-10-2
Danger of explosion of flammable gases and vapours	BE3N2	ZONE 2	ČSN EN 60079-14, ČSN EN 60079-10-1



EXTRA-N-LED

IP 66 / Ex zone 2, 22

5 year warranty

SILICONE FREE



IK10 (5kg@40cm)



FTZÚ 16 ATEX 0102X



Application: Dustproof lighting fixture EXTRA-N-LED with splash water resistance designed for lighting of areas with danger of explosion. The lighting fixture is certified by FTZU Ostrava-Radvanice (certificate type FTZU 16 ATEX 0102X).

Ballast: EP – electronic 220 – 240 V, 50/60 Hz, 220 – 240 V, 0 Hz DC

Light source: LED, 4000K, CRI +80, MacAdam3

Housing: Plastic material PC (polycarbonate), grey colour RAL 7035

Diffuser: PC (polycarbonate) opal

Fastening: Surface ceiling or wall mounting by means of two self-locking fastening brackets (standard equipment) or (optional) set of wall brackets - angle 45°, pole mounting via set of pole brackets, suspension by means of wire or cable suspension.

Connection: Screwless three-pole terminal block, maximum diameter of wires 2.5 mm²

Standard equipment: 1pc EX plastic cable gland M20x1.5 (as a standard for diameter of cable 7-12mm), 1 pc EX plastic plug M20x1.5, 2 pcs stainless steel fastening bracket-AISI 304, stainless clips, double cable clip.

Calculated lifetime – LED modules: L80B10 ta30 – 70 000h, L70B10 ta30 – 100 000h

EXTRA-N-LED, MULTIEXTRA-N-LED, EXTRA-N-LED-Em

Ⓜ II 3G Ex nR IIC T6 Gc

Ⓜ II 3D Ex tc IIIC T80°C Dc

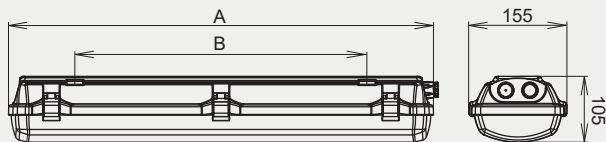

Order number	Name	Lighting fixture luminous flux (lm)	Power input (W)	Rated power output (lm/W)	Ta max (°C)	Dimensions of lighting fixture A (mm)	Mounting spacing B (mm)	Weight (kg)
4000K								
055660	EXTRA-N-LED-1250-218-G2-4K, IP66	1125	8	150	60	670	460	1,8
055661	EXTRA-N-LED-2500-218-G2-4K, IP66	2251	15	150	60	670	460	1,8
055662	EXTRA-N-LED-5000-218-G2-4K, IP66	4357	29	150	55	670	460	1,7
055663	EXTRA-N-LED-2500-236-G2-4K, IP66	2251	15	155	60	1280	880	3,1
055664	EXTRA-N-LED-5000-236-G2-4K, IP66	4503	29	155	60	1280	880	3,1
055665	EXTRA-N-LED-10000-236-G2-4K, IP66	8715	58	150	40	1280	880	3,2
055666	EXTRA-N-LED-3750-258-G2-4K, IP66	3664	24	154	55	1580	1000	3,6
055667	EXTRA-N-LED-7500-258-G2-4K, IP66	7238	47	154	55	1580	1000	3,6
055668	EXTRA-N-LED-12550-258-G2-4K, IP66	11172	74	151	45	1580	1000	3,8
055669	EXTRA-N-LED-16700-258-G2-4K, IP66	13730	94	146	40	1580	1000	3,8
055670	EXTRA-N-LED-20000-258-G2-4K, IP66	16311	115	142	40	1580	1000	3,8

Tolerance of luminous flux and power input of the lighting fixture +/- 10%



SAFE answers to HAZARDOUS questions

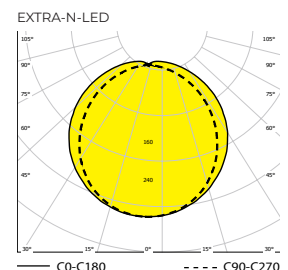

Accessories on request

	Suspended mounting 051131 Cable suspension-EXTRA-2x (3m)		064643 Set of wall brackets - angle 45° EXTRA (2 pcs)
	Suspended mounting 001696 Wire suspension EXTRA (Chain not included)		051157 Pole bracket EXTRA (for Ø 50 mm)
	001748 LAK Protective cage EXTRA 18W 001749 LAK Protective cage EXTRA 36W 001750 LAK Protective cage EXTRA 58W		Colour coated diffuser e.g. GREEN = Safety showers

Standard accessories M20		Accessories for armoured cable M20		Nickel-plated accessories M20	
008060	Plastic cable gland Ex M20x1.5	008052	Cable gland BIMED M20x1.5 ORION UNIVERSAL (8+/- 0.5Nm)	008092	Cable gland WISKA EMSKE20 M20x1.5 Ex-nickel-plated brass (8 Nm)
007047N	Flat sealing ring EPDM 27x18.5x1.5 mm	008091	Sealing plug WISKA EMVS20 M20x1.5 Ex-nickel-plated brass	008093	Nut WISKA EMMU20 M20x1.5 - nickel-plated brass
008090	Plastic sealing plug Ex M20x1.5	008093	Nut WISKA EMMU20 M20x1.5 -nickel-plated brass	008091	Sealing plug WISKA EMVS20 M20x1.5 Ex-nickel-plated brass
008097	Plastic nut WISKA EMUG 20 M20x1.5	007047N	Flat sealing ring EPDM 27x18.5x1.5 mm	007047N	Flat sealing ring EPDM 27x18.5x1.5 mm

Lighting fixture detail



On request

DIM – dimmable electronic ballast (DALI,DSI, 1-10V)

GESIS – possibility to equip lighting fixtures with connectors

NANO – lighting fixtures can be protected by special nano-layer (hydrophobic, oleophobic or antibacterial protection)

EM-1/3 - non-maintained emergency lighting

MULTI-1/3 - maintained emergency lighting

2.7K-6.5K - colour temperature

1/3 F - single-phase or three phase through wiring connection 2.5 mm²

Stadard order number	MULTI-1H	MULTI-3H	DALI	1F	3F
055660	055688	055695	055671	055660 1F	055660 3F
055661	055689	055696	055672	055661 1F	055661 3F
055662			055673	055662 1F	055662 3F
055663	055690	055697	055674	055663 1F	055663 3F
055664	055691	055698	055675	055664 1F	055664 3F
055665		055701LO*	055676	055665 1F	055665 3F
055666	055692	055699	055677	055666 1F	055666 3F
055667	055693	055700	055678	055667 1F	055667 3F
055668	055694	055701	055679	055668 1F	055668 3F
055669			055680	055669 1F	055669 3F
055670			055681	055670 1F	055670 3F

055701LO* - Due to the amount of internal heat generated, the emergency version of 055665 is only available in a 5ft body

EM

055682	EXTRA-N-LED-Em-500-218-G2-4K, IP66, 1h	055685	EXTRA-N-LED-Em-500-218-G2-4K, IP66, 3h
055683	EXTRA-N-LED-Em-500-236-G2-4K, IP66, 1h	055686	EXTRA-N-LED-Em-500-236-G2-4K, IP66, 3h
055684	EXTRA-N-LED-Em-500-258-G2-4K, IP66, 1h	055687	EXTRA-N-LED-Em-500-258-G2-4K, IP66, 3h

Use of lighting fixtures in areas with danger of explosion

Danger of explosion of flammable dust
 Danger of explosion of flammable gases and vapours

Marking of external influences

BE3N1
 BE3N2

Marking
 ZONE 22
 ZONE 2

Area classification

Directive
 ČSN EN 60079-14, ČSN EN 60079-10-2
 ČSN EN 60079-14, ČSN EN 60079-10-1

STL International Ltd

Hill Farm, Linton Hill, Maidstone, Kent, ME17 4AL, UK T. +44 (0)1622 749633 eMail. solutions@stl-int.co.uk Web. www.stl-int.co.uk



SALUKA-N-LED

IP 66 / Ex zone 2, 22

5 year warranty

SILICONE FREE



FTZÚ 17 ATEX 0027X



Application: Dustproof lighting fixture SALUKA-N-LED with splash water resistance designed for lighting of areas with danger of explosion. The lighting fixture is certified by FTZU Ostrava-Radvanice (certificate type FTZU 17 ATEX 0027X).

Ballast: EP – electronic 220-240V/50-60Hz, 220-240V, 0 Hz DC

Light source: LED, 4000K, CRI +80, MacAdam3

Housing: White painted steel sheet RAL 9003

Diffuser: Opal tempered safety glass

Reflector: White painted steel sheet RAL 9003

Fastening: Direct surface wall or ceiling mounting, ceiling mounting by means of ceiling brackets or adjustable brackets, wall mounting by means of wall arm brackets, pole mounting by means of pole brackets, suspension via set of suspension hooks (standard equipment)

Connection: Screwless three-pole terminal block, maximum diameter of wires 2.5 mm²

Standard equipment: 1 pc M20 cable gland for diameter of cable 7-12 mm, 1 pc M20 sealing plug, 2 pcs suspending hook, 2 pcs rubber gasket

Calculated lifetime – LED modules: L80B10 ta40 – 70 000h, L70B10 ta40 – 100 000h

SALUKA-N-LED, MULTISALUKA-N-LED, SALUKA-N-LED-Em

Ⓜ II 3G Ex nR IIC T6 Gc

Ⓜ II 3D Ex tc IIC T80°C Dc

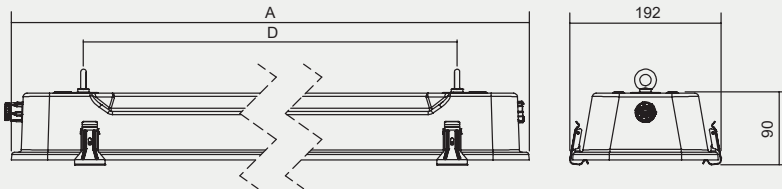

Order number	Name	Lighting fixture luminous flux (lm)	Power input (W)	Rated power output (lm/W)	Ta max (°C)	Dimensions of lighting fixture A x B x C (mm)	Mounting spacing D (mm)	Weight (kg)
080000	SALUKA-N-LED-OP-1250-218-G2-4K	1155	8	145	45	705x192x90	510	3,8
080001	SALUKA-N-LED-OP-2500-218-G2-4K	2220	15	148	60	705x192x90	510	3,8
080002	SALUKA-N-LED-OP-5000-218-G2-4K	4409	29	153	55	705x192x90	510	3,9
080003	SALUKA-N-LED-OP-2500-236-G2-4K	2220	15	148	60	1305x192x90	1110	7,1
080004	SALUKA-N-LED-OP-5000-236-G2-4K	4440	29	154	60	1305x192x90	1110	7,1
080005	SALUKA-N-LED-OP-10000-236-G2-4K	8819	58	153	50	1305x192x90	1110	7,2
080006	SALUKA-N-LED-OP-3750-258-G2-4K	3330	22	152	55	1605x192x90	1410	8,1
080007	SALUKA-N-LED-OP-7500-258-G2-4K	6661	44	152	55	1605x192x90	1410	8,1
080008	SALUKA-N-LED-OP-12550-258-G2-4K	11305	74	153	45	1605x192x90	1410	8,3
080009	SALUKA-N-LED-OP-16700-258-G2-4K	14175	95	150	50	1605x192x90	1410	8,5
080010	SALUKA-N-LED-OP-20000-258-G2-4K	16963	117	145	45	1605x192x90	1410	8,5

Tolerance of luminous flux and power input of the lighting fixture +/- 10%

SALUKA-N-LED

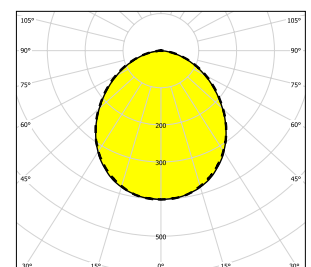

— C0-C180

- - - C90-C270

Accessories on request



051139 Set of ceiling brackets SALUKA (2 pcs)

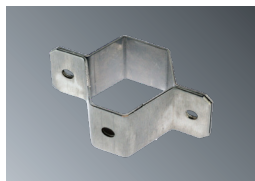

051145 Pole bracket SALUKA stainless steel (for Ø 50 mm)

051146 Pole bracket PITBUL/SALUKA (pro Ø 50 mm)

064018 Pole bracket SALUKA stainless steel (for Ø 40 mm)

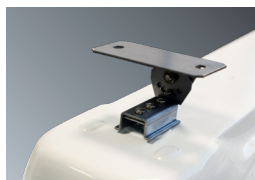

063754 Set of adjustable brackets SALUKA (2 ks)



051147 Stainless steel wall arm bracket SALUKA 60° (1 pc)

Standard accessories M20

007047N	Flat sealing ring EPDM 27x18.5x1.5 mm
008060	Cable gland Ex M20x1.5
008097	Plastic nut WISKA EMUG 20 M20x1.5
008090	Sealing plug Ex M20x1.5

Accessories for armoured cable M20

008052	Cable gland BIMED M20x1.5 ORION UNIVERSAL (8+/- 0.5Nm)
008091	Sealing plug WISKA EMVS20 M20x1.5 Ex-nickel-plated brass
008093	Nut WISKA EMMU20 M20x1.5 - nickel-plated brass
007047N	Flat sealing ring EPDM 27x18.5x1.5 mm

Nickel-plated accessories M20

008092	Cable gland WISKA EMSKE20 M20x1.5 Ex-nickel-plated brass (8 Nm)
008093	Nut WISKA EMMU20 M20x1.5 - nickel-plated brass
008091	Sealing plug WISKA EMVS20 M20x1.5 Ex-nickel-plated brass
007047N	Flat sealing ring EPDM 27x18.5x1.5 mm

Lighting fixture detail



On request

DIM – dimmable electronic ballast (DALI,DSI, 1-10V)

GESIS – possibility to equip lighting fixtures with connectors

MULTI-1/3 - maintained emergency lighting

EM-1/3 - non-maintained emergency lighting

NANO - lighting fixtures can be protected by special nano-layer (hydrophobic, oleophobic or antibacterial protection)

2.7K-6.5K - colour temperature

1/3 F - single-phase or three phase through wiring connection, maximum diameter of wires 1.5 mm²

NEREZ – (in case of STAINLESS STEEL version its declared for ambient temperature decreased about 5-10°C)

Standard order number	MULTI-1H	MULTI-3H	DALI	1F	3F	EM-1H	EM-3H
080000	080028	080036	080011	080000 1F 2,5 MM2	080000 3F 2,5 MM2	X	X
080001	080029	080037	080012	080001 1F 2,5 MM2	080001 3F 2,5 MM2	80022	80025
080002	X	X	080013	080002 1F 2,5 MM2	080002 3F 2,5 MM2	X	X
080003	080030	080038	080014	080003 1F 2,5 MM2	080003 3F 2,5 MM2	X	X
080004	080031	080039	080015	080004 1F 2,5 MM2	080004 3F 2,5 MM2	80023	80026
080005	080032	080040	080016	080005 1F 2,5 MM2	080005 3F 2,5 MM2	X	X
080006	080033	080041	080017	080006 1F 2,5 MM2	080006 3F 2,5 MM2	X	X
080007	080034	080042	080018	080007 1F 2,5 MM2	080007 3F 2,5 MM2	80024	80027
080008	080035	080043	080019	080008 1F 2,5 MM2	080008 3F 2,5 MM2	X	X
080009	X	X	080020	080009 1F 2,5 MM2	080009 3F 2,5 MM2	X	X
080010	X	X	080021	080010 1F 2,5 MM2	080010 3F 2,5 MM2	X	X

Use of lighting fixtures in areas with danger of explosion

Danger of explosion of flammable dust	BE3N1
Danger of explosion of flammable gases and vapours	BE3N2

Marking of external influences

BE3N1
BE3N2

Area classification

Marking	Directive
ZONE 22	ČSN EN 60079-14, ČSN EN 60079-10-2
ZONE 2	ČSN EN 60079-14, ČSN EN 60079-10-1

STL International Ltd

Hill Farm, Linton Hill, Maidstone, Kent, ME17 4AL, UK T. +44 (0)1622 749633 eMail. solutions@stl-int.co.uk Web. www.stl-int.co.uk



PITBUL-N-LED

IP 65 / zone 2, 22

5 year warranty

SILICONE FREE

IK10 (5kg@40cm)



FTZÚ 17 ATEX 0129X



Application: Dustproof lighting fixture PITBUL-N-LED with splash water resistance designed for lighting of areas with danger of explosion. The lighting fixture is certified by FTZU Ostrava-Radvanice (certificate type FTZU 17 ATEX 0129X).

Ballast: EP – electronic 220-240 V, 50/60 Hz, 220 – 240 V, 0 Hz DC

Light source: LED, 4000K, CRI +80, MacAdam3

Housing: White painted steel sheet RAL 9003

Diffuser: Opal hardened safety glass

Fastening: Direct surface mounting by means of M8 screws, suspension via suspending brackets, recessed mounting via the frame, ceiling mounting via set of ceiling brackets, pole mounting via set of pole brackets, wall mounting via set of adjustable brackets.

Connection: Screwless three-pole terminal block, maximum diameter of wires 2.5 mm²

Standard equipment: 1pc EX plastic cable gland M20x1,5 for diameter of cable 7-12mm, 1pc EX plastic sealing plug

Calculated lifetime – LED modules: L80B10 ta35 – 70 000h, L70B10 ta35 – 100 000h

PITBUL-N-LED, MULTIPITBUL-N-LED, PITBUL-N-LED-Em

Ⓢ II 3G Ex nR IIC T6 Gc

Ⓢ II 3D Ex tc IIIC T63°C Dc

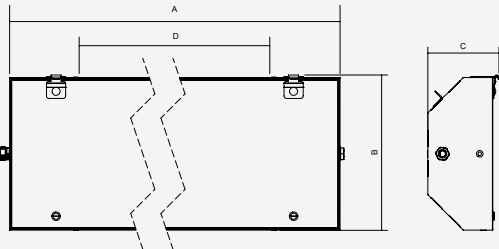



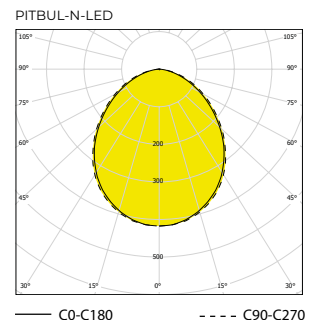

Order number	Name	Lighting fixture luminous flux (lm)	Power input (W)	Rated power output (lm/W)	Ta max (°C)	Dimensions of lighting fixture A x B x C (mm)	Mounting spacing D (mm)	Weight (kg)
053790	PITBUL-N-LED-OP-5000-218-4K	4470	35	128	65	703x310x142	450	9,1
053791	PITBUL-N-LED-OP-10000-236-4K	8940	70	128	55	1313x310x142	800	13,8
053792	PITBUL-N-LED-OP-15000-258-4K	13410	104	129	55	1613x310x142	1100	16,6
053793	PITBUL-N-LED-OP-10000-418-4K	8899	70	127	55	703x369x142	450	8,9
053794	PITBUL-N-LED-OP-18300-436-4K	15895	121	131	50	1313x369x142	800	16,1
053795	PITBUL-N-LED-OP-29000-458-4K	24845	195	127	45	1613x369x142	1100	19,6

Tolerance of luminous flux and power input of the lighting fixture +/- 10%

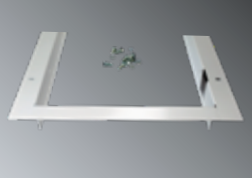

Lighting fixtures for areas with danger of explosions

Accessories on request

	053941 Set of recessed frame PITBUL 1x-3x18W 053942 Set of recessed frame PITBUL 4x18W 053943 Set of recessed frame PITBUL 1x-3x36W 053944 Set of recessed frame PITBUL 4x36W 053945 Set of recessed frame PITBUL 1x-3x58W 053946 Set of recessed frame PITBUL 4x58W		054935 Set of stainless steel ceiling brackets PITBUL (2 pcs)
	053940 Set of adjustable brackets PITBUL		004642 Suspension bracket DIN 580 M8 - 1 pc
	051146 Pole bracket PITBUL (for Ø 50 mm)	Accessories for armoured cable M20 008052 Cable gland BIMED M20x1.5 ORION UNIVERSAL (8+/- 0.5Nm) 008091 Sealing plug WISKA EMVS20 M20x1.5 Ex-nickel-plated brass 008093 Nut WISKA EMMU20 M20x1.5 - nickel-plated brass 007047N Flat sealing ring EPDM 27x18.5x1.5 mm	

Accessories for armoured cable M25

008056	BIMED KBA 2M(25) Brass M25x1.5
008089	Plastic Ex sealing plug M25x1.5
008035	Nut WISKA EMMU25 M25x1.5 - nickel-plated brass
007075	Flat sealing ring EPDM 32x23.5x1.5 mm

Accessories M25

008061	Cable gland OBO V-TEC EX M25x1.5 - 2050331 (5.0 Nm)
008089	plastic Ex sealing plug M25x1.5
008102	Plastic nut WISKA EMUG 25 M25x1.5 black
007075	Flat sealing ring EPDM 32x23.5x1.5 mm

Nickel-plated accessories M20

008092	Cable gland WISKA EMSKE20 M20x1.5 Ex-nickel-plated brass (8 Nm)
008093	Nut WISKA EMMU20 M20x1.5 - nickel-plated brass
008091	Sealing plug WISKA EMVS20 M20x1.5 Ex-nickel-plated brass
007047N	Flat sealing ring EPDM 27x18.5x1.5 mm

Lighting fixture detail



On request

DIM – dimmable electronic ballast (DALI, DSI, 1-10V)

GESIS – possibility to equip lighting fixtures with connectors

MULTI-1/3 - maintained emergency lighting

EM-1/3 - non-maintained emergency lighting

NANO – lighting fixtures can be protected by special nano-layer oleophobic or antibacterial protection)

2.7K-6.5K - colour temperature

RAL - other colour scale

1/3 F - single-phase or three phase through wiring connection, maximum diameter of wires 1.5 mm²

NEREZ - housing produced from stainless steel AISI 304 or AISI 316 (in case of STAINLESS STEEL version its declared for ambient temperature decreased about 5-10°C)

Stadard order number	MULTI-1H	MULTI-3H	DALI	1F	3F
053790	053530	053536	053542	053790 1F	053790 3F
053791	053531	053537	053543	053791 1F	053791 3F
053792	053532	053538	053544	053792 1F	053792 3F
053793	053533	053539	053545	053793 1F	053793 3F
053794	053534	053540	053546	053794 1F	053794 3F
053795	053535	053541	053547	053795 1F	053795 3F

Use of lighting fixtures in areas with danger of explosion	Marking of external influences	Area classification	
		Marking	Directive
Danger of explosion of flammable dust	BE3N1	ZONE 22	ČSN EN 60079-14, ČSN EN 60079-10-2
Danger of explosion of flammable gases and vapours	BE3N2	ZONE 2	ČSN EN 60079-14, ČSN EN 60079-10-1

STL International Ltd

Hill Farm, Linton Hill, Maidstone, Kent, ME17 4AL, UK T. +44 (0)1622 749633 eMail. solutions@stl-int.co.uk Web. www.stl-int.co.uk



NORD-N-LED-OPG

IP 66 / Ex zone 2, 22

5 year warranty

SILICONE FREE

IK10 (5kg@40cm)



CE	EMC	EAC	ta -20°C min	EVG	EVG DIMM	LED	5 years Warranty	RoHS	nanotechnology	Ex	220-240 V 50-60 Hz	220-240V 0 Hz	IK 10	FTZÚ 17 ATEX 0026X
----	-----	-----	--------------	-----	----------	-----	------------------	------	----------------	----	--------------------	---------------	-------	--------------------

Application: The dustproof recessed lighting fixture NORD-N-LED with splash water resistance is designed for areas with danger of explosions. They can be used in paint boxes and paint shops. The lighting fixture is certified by FTZU Ostrava-Radvanice (certificate type FTZU 17 ATEX 0026X).

Ballast: EP – electronic 220-240V/50-60Hz AC, 220-240V, 0 Hz DC

Light source: LED, 4000K, CRI +80, MacAdam3

Housing: White painted steel sheet RAL 9003

Diffuser: OPG – opal hardened safety glass in a frame

Reflector: White painted steel sheet RAL 9003

Fastening: Recessed ceiling mounting (it is necessary to ensure sufficiently strong supporting base)

Connection: Screwless three-pole terminal block, max. diameter of wires 2.5 mm²

Standard equipment: 2 pcs EX M20 cable glands for diameter of cable 7-12mm and 3 pcs EX M20 sealing plug

Calculated lifetime – LED modules: L80B10 ta35 – 70 000h
L70B10 ta35 – 100 000h

NORD-N-LED, MULTINORD-N-LED, NORD-N-LED-Em

Ⓜ II 3G Ex nR IIC T6 Gc

Ⓜ II 3D Ex tc IIIC T80 °C Dc

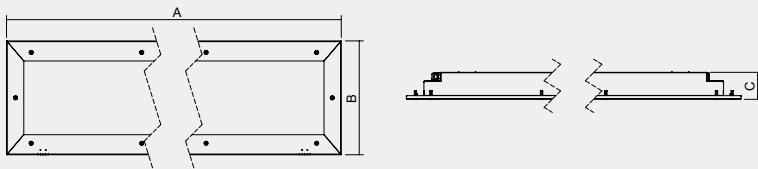

Order number	Name	Lighting fixture luminous flux (lm)	Power input (W)	Rated power output (lm/W)	Ta max (°C)	Dimensions of lighting fixture A x B x C (mm)	Mounting hole (mm)	Weight (kg)
080100	NORD-N-LED-OPG-5000-218-G2-4K	4524	29	156	60	767x386x92	720x330	9,5
080101	NORD-N-LED-OPG-10000-236-G2-4K	9048	58	156	50	1367x386x92	1320x330	16,3
080102	NORD-N-LED-OPG-15000-258-G2-4K	13572	88	154	45	1667x386x92	1620x330	20,9
080103	NORD-N-LED-OPG-10000-418-G2-4K	9172	58	158	55	767x536x92	720x480	13,4
080104	NORD-N-LED-OPG-18300-436-G2-4K	16489	103	160	50	1367x536x92	1320x480	22,4
080105	NORD-N-LED-OPG-29000-458-G2-4K	26322	166	159	45	1667x536x92	1620x480	27,7

Tolerance of luminous flux and power input of the lighting fixture +/- 10%

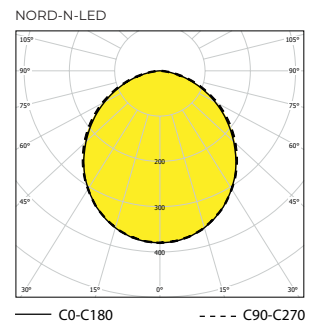

Accessories on request

Standard accessories M20

008060	Plastic cable gland Ex M20x1.5
007047N	Flat sealing ring EPDM 27x18.5x1.5 mm
008097	Plastic nut WISKA EMUG 20 M20x1.5
008090	Sealing plug Ex M20x1.5

Accessories for armoured cable M20

008052	Cable gland BIMED M20x1.5 ORION UNIVERSAL (8+/- 0.5Nm)
008091	Sealing plug WISKA EMVS20 M20x1.5 Ex-nickel-plated brass
008093	Nut WISKA EMMU20 M20x1.5 - nickel-plated brass
007047N	Flat sealing ring EPDM 27x18.5x1.5 mm

Accessories for armoured cable M25

008056	BIMED KBA 2M(25) Brass M25x1.5
008089	Plastic sealing plug Ex M25x1.5
008035	Nut WISKA EMMU25 M25x1.5 - nickel-plated brass
007075	Flat sealing ring EPDM 32x23.5x1.5 mm

Standard accessories M25

008061	Cable gland OBO V-TEC EX M25x1.5 - 2050331 (5.0 Nm)
008089	Plastic sealing plug Ex M25x1.5
008102	Plastic nut WISKA EMUG 25 M25x1.5 black
007075	Flat sealing ring EPDM 32x23.5x1.5 mm

Nickel-plated accessories M20

008092	Cable gland WISKA EMSKE20 M20x1.5 Ex-nickel-plated brass (8 Nm)
008093	Nut WISKA EMMU20 M20x1.5 - nickel-plated brass
008091	Sealing plug WISKA EMVS20 M20x1.5 Ex-nickel-plated brass
007047N	Flat sealing ring EPDM 27x18.5x1.5 mm

Lighting fixture detail



On request

DIM – dimmable electronic ballast (DALI)

2.7K-6.5K - colour temperature

EM-1h/3h - non-maintained emergency lighting

MULTI-1h/3h - maintained emergency lighting

1/3 F - single-phase or three phase through wiring connection, max. diameter of wires 2.5mm²

NEREZ – housing produced from stainless steel AISI 304 or AISI 316

(in case of the design STAINLESS, the ambient temperature lower by approximately 5-10°C)

RAL - other colour scale

NANO lighting fixtures can be protected by special nano-layer (hydrophobic, oleophobic or antibacterial protection)

Standard order number	MULTI-1H	MULTI-3H	DALI	1F	3F
080100	080106	080112	080100 DALI	080100 1F	080100 3F
080101	080107	080113	080101 DALI	080101 1F	080101 3F
080102	080108	080114	080102 DALI	080102 1F	080102 3F
080103	080109	080115	080103 DALI	080103 1F	080103 3F
080104	080110	080116	080104 DALI	080104 1F	080104 3F
080105	080111	080117	080105 DALI	080105 1F	080105 3F

Use of lighting fixtures in areas with danger of explosion	Marking of external influences	Area classification	
		Marking	Directive
Danger of explosion of flammable dust	BE3N1	ZONE 22	ČSN EN 60079-14, ČSN EN 60079-10-2
Danger of explosion of flammable gases and vapours	BE3N2	ZONE 2	ČSN EN 60079-14, ČSN EN 60079-10-1



NORD-N-LED-CG

IP 66 / Ex zone 2, 22

5 year warranty

SILICONE FREE

IK10 (5kg@40cm)



CE	EMC	EAC	ta -20°C min	EVG	EVG DIMM	LED	5 years Warranty	nanotechnology	Ex	220-240 V 50-60 Hz	220-240V 0 Hz	IK 10	FTZÚ 17 ATEX 0026X
----	-----	-----	--------------	-----	----------	-----	------------------	----------------	----	--------------------	---------------	-------	--------------------

Application: The dustproof recessed lighting fixture NORD-N-LED with splash water resistance is designed for areas with danger of explosions. They can be used in paint boxes and paint shops. The lighting fixture is certified by FTZU Ostrava-Radvanice (certificate type FTZU 17 ATEX 0026X).

Ballast: EP – electronic 220-240V/50-60Hz AC, 220-240V, 0 Hz DC

Light source: LED, 4000K, CRI +80, MacAdam3

Housing: White painted steel sheet RAL 9003

Diffuser: CG – clear hardened safety glass in a frame

Optics: ACL LINEAR LENS 24mm BATWING

Reflector: White painted steel sheet RAL 9003

Fastening: Recessed ceiling mounting (it is necessary to ensure sufficiently strong supporting base)

Connection: Screwless three-pole terminal block, max. diameter of wires 2.5 mm²

Standard equipment: 2 pcs EX M20 cable glands for diameter of cable 7-12mm and 3 pcs EX M20 sealing plug

Calculated lifetime – LED modules: L80B10 ta35 – 70 000h, L70B10 ta35 – 100 000h

NORD-N-LED, MULTINORD-N-LED, NORD-N-LED-Em

Ⓜ II 3G Ex nR IIC T6 Gc

Ⓜ II 3D Ex tc IIIC T80 °C Dc

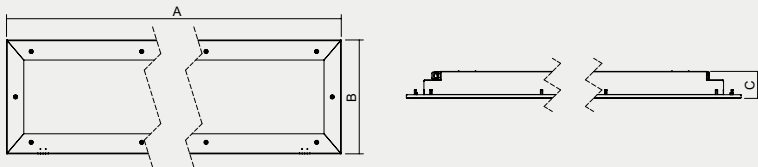

Order number	Name	Lighting fixture luminous flux (lm)	Power input (W)	Rated power output (lm/W)	Ta max (°C)	Dimensions of lighting fixture A x B x C (mm)	Mounting hole (mm)	Weight (kg)	Replacement of T8 (W)
080120	NORD-N-LED-CG-2100-218-G2-4K	1830	11	166	60	767x386x92	720x330	9,5	2x18
080123	NORD-N-LED-CG-3400-418-G2-4K	2899	18	161	55	767x536x92	720x480	13,4	3x18
080126	NORD-N-LED-CG-4000-418-G2-4K	3593	22	163	55	767x536x92	720x480	13,4	4x18
080121	NORD-N-LED-CG-5100-236-G2-4K	4669	30	155	50	1367x386x92	1320x330	16,3	2x36
080124	NORD-N-LED-CG-8200-436-G2-4K	7186	45	159	50	1367x536x92	1320x480	22,4	3x36
080127	NORD-N-LED-CG-9500-436-G2-4K	8538	54	158	50	1367x536x92	1320x480	22,4	4x36
080122	NORD-N-LED-CG-8000-258-G2-4K	7396	47	157	45	1667x386x92	1620x330	20,9	2x58
080125	NORD-N-LED-CG-12500-458-G2-4K	10779	67	160	45	1667x536x92	1620x480	27,7	3x58
080128	NORD-N-LED-CG-15000-458-G2-4K	12807	81	158	45	1667x536x92	1620x480	27,7	4x58

Tolerance of luminous flux and power input of the lighting fixture +/- 10%

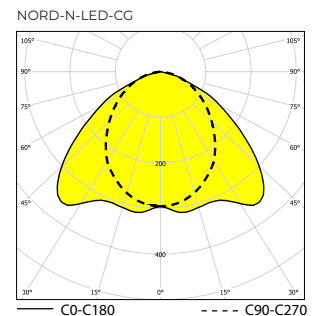

Accessories on request

Standard accessories M20

008060	Plastic cable gland Ex M20x1.5
007047N	Flat sealing ring EPDM 27x18.5x1.5 mm
008097	Plastic nut WISKA EMUG 20 M20x1.5
008090	Sealing plug Ex M20x1.5

Accessories for armoured cable M20

008052	Cable gland BIMED M20x1.5 ORION UNIVERSAL (8+/- 0.5Nm)
008091	Sealing plug WISKA EMVS20 M20x1.5 Ex-nickel-plated brass
008093	Nut WISKA EMMU20 M20x1.5 - nickel-plated brass
007047N	Flat sealing ring EPDM 27x18.5x1.5 mm

Accessories for armoured cable M25

008056	BIMED KBA 2M(25) Brass M25x1.5
008089	Plastic sealing plug Ex M25x1.5
008035	Nut WISKA EMMU25 M25x1.5 - nickel-plated brass
007075	Flat sealing ring EPDM 32x23.5x1.5 mm

Standard accessories M25

008061	Cable gland OBO V-TEC EX M25x1.5 - 2050331 (5.0 Nm)
008089	Plastic sealing plug Ex M25x1.5
008102	Plastic nut WISKA EMUG 25 M25x1.5 black
007075	Flat sealing ring EPDM 32x23.5x1.5 mm

Nickel-plated accessories M20

008092	Cable gland WISKA EMSKE20 M20x1.5 Ex-nickel-plated brass (8 Nm)
008093	Nut WISKA EMMU20 M20x1.5 - nickel-plated brass
008091	Sealing plug WISKA EMVS20 M20x1.5 Ex-nickel-plated brass
007047N	Flat sealing ring EPDM 27x18.5x1.5 mm

Lighting fixture detail



On request

DIM – dimmable electronic ballast (DALI)

2.7K-6.5K - colour temperature

EM-1h/3h - non-maintained emergency lighting

MULTI-1h/3h - maintained emergency lighting

1/3 F - single-phase or three phase through wiring connection, max. diameter of wires 2.5mm²

NEREZ – housing produced from stainless steel AISI 304 or AISI 316

(in case of the design STAINLESS, the ambient temperature lower by approximately 5-10°C)

RAL - other colour scale

NANO lighting fixtures can be protected by special nano-layer (hydrophobic, oleophobic or antibacterial protection)

Standard order number	MULTI-1H	MULTI-3H	DALI	1F	3F
080120	080129	080138	080120 DALI	080120 1F	080120 3F
080121	080130	080139	080121 DALI	080121 1F	080121 3F
080122	080131	080140	080122 DALI	080122 1F	080122 3F
080123	080132	080141	080123 DALI	080123 1F	080123 3F
080124	080133	080142	080124 DALI	080124 1F	080124 3F
080125	080134	080143	080125 DALI	080125 1F	080125 3F
080126	080135	080144	080126 DALI	080126 1F	080126 3F
080127	080136	080145	080127 DALI	080127 1F	080127 3F
080128	080137	080146	080128 DALI	080128 1F	080128 3F

Use of lighting fixtures in areas with danger of explosion	Marking of external influences	Area classification	
		Marking	Directive
Danger of explosion of flammable dust	BE3N1	ZONE 22	ČSN EN 60079-14, ČSN EN 60079-10-2
Danger of explosion of flammable gases and vapours	BE3N2	ZONE 2	ČSN EN 60079-14, ČSN EN 60079-10-1



EXTRA-LED-PLUS/FROST

IP 66

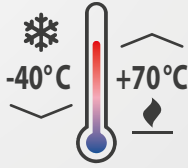

5 year warranty

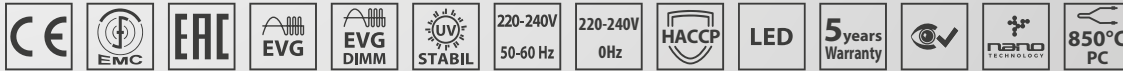

Application: Dustproof lighting fixture of new generation EXTRA-LED-PLUS/FROST with splash water resistance is designed for workshops, warehouses, production areas and garages with higher ambient temperature.

Ballast: EP – electronic 220-240 V/50-60 Hz AC, 220-240 V DC

Light source: LED, 4000K, CRI +80, MacAdam3

Housing: Plastic material PC (polycarbonate), grey colour RAL 7035

Diffuser: PC (polycarbonate), opal

Fastening: Surface ceiling or wall mounting by means of two self-locking fastening brackets (standard equipment) or set of wall brackets - angle 45°, pole mounting via set of pole brackets, suspension by means of wire or cable suspenders.

Connection: Screwless three-pole terminal block, maximum diameter of wires 2.5 mm².

Standard equipment: Cable gland M20 for diameter of cable 7-12mm and fastening brackets for direct fastening of lighting fixtures to a mounting surface and stainless clips.

Calculated lifetime – LED modules:

L80B10 ta30 – 70 000h
L70B10 ta30 – 100 000h

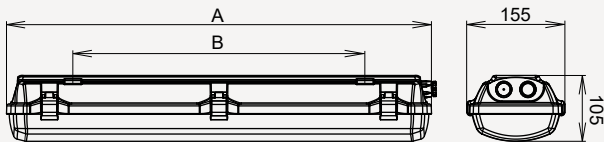

Order number	Name	Lighting fixture luminous flux (lm)	Power input (W)	Rated power output (lm/W)	Ta max (°C)	Dimensions of lighting fixture A (mm)	Mounting spacing B (mm)	Weight (kg)
054480	EXTRA-LED-PLUS/FROST-1R-5000-236-4K	4347	28	155	70	1280	880	7,1
054481	EXTRA-LED-PLUS/FROST-2R-10000-236-4K	8694	56	155	60	1280	880	7
054482	EXTRA-LED-PLUS/FROST-1R-4750-258-4K	4221	26	162	70	1580	1000	8,1
054483	EXTRA-LED-PLUS/FROST-1R-7500-258-4K	6776	43	158	65	1580	1000	8,1
054484	EXTRA-LED-PLUS/FROST-2R-12500-258-4K	10911	69	158	60	1580	1000	8,3

Tolerance of luminous flux and power input of the lighting fixture +/- 10%

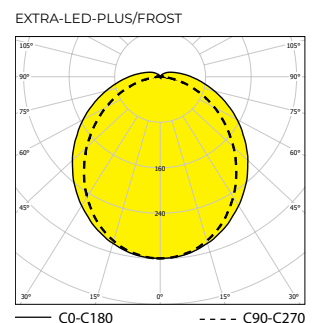

Accessories on request



001696 Wire suspension EXTRA



051131 Cable suspension-EXTRA-2x (3m)



064643 Set of wall brackets - angle 45° EXTRA (2 pcs)



051157 Pole bracket EXTRA (for Ø 50 mm)

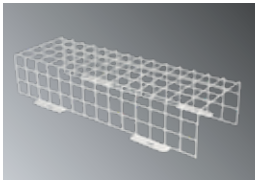

001748 LAK Protective cage EXTRA 18W

001749 LAK Protective cage EXTRA 36W

001750 LAK Protective cage EXTRA 58W



008006N Cable gland ESKV M20x1.5

008088 Ventilation plug EVPS 20, grey RAL 7035

008097 Plastic nut WISKA EMUG 20 M20x1.5

Lighting fixture detail

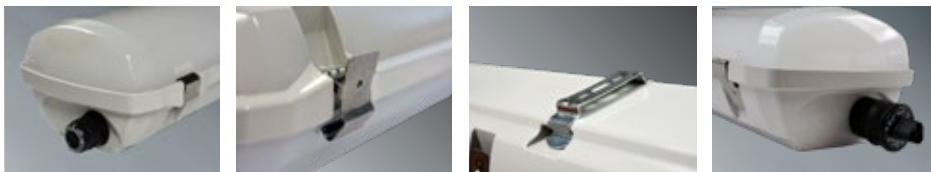

On request

GESIS – possibility to equip lighting fixtures with connectors

1/3 F - single-phase or three phase through wiring connection, maximum diameter of wires 2.5 mm²

NANO – lighting fixtures can be protected by special nano-layer (hydrophobic, oleophobic or antibacterial protection)

2.7K-6.5K - colour temperature

DIM – dimmable electronic ballast (DALI)

NUP - stainless fastening bracket

NSPP - stainless steel clip and fastening bracket

Standard order number	EM-1H	EM-3H	MULTI-1H	MULTI-3H	DALI	1F	3F
054480	X	X	X	X	054480 DALI	054480 1F	054480 3F
054481	X	X	X	X	054481 DALI	054481 1F	054481 3F
054482	X	X	X	X	054482 DALI	054482 1F	054482 3F
054483	X	X	X	X	054483 DALI	054483 1F	054483 3F
054484	X	X	X	X	054484 DALI	054484 1F	054484 3F



SALUKA-LED-PLUS/FROST

IP 66

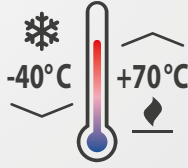

5 year warranty

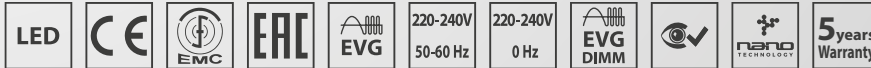

Application: Metal dustproof lighting fixture SALUKA-LED-PLUS/FROST with splash water resistance designed for workshops, garages, industrial and production areas with higher ambient temperature, or warehouses and freezers with low temperature.

Ballast: EP – electronic 220-240 V/50-60 Hz AC, 220-240 V DC

Light source: LED, 4000K, CRI +80, MacAdam3

Housing: White painted steel sheet RAL 9003

Diffuser: Clear hardened safety glass
OP - matt hardened safety glass

Reflector: White painted steel sheet RAL 9003

Fastening: Direct surface wall or ceiling mounting, ceiling mounting by means of ceiling brackets or adjustable brackets, wall mounting by means of wall arm brackets, pole mounting by means of pole brackets, suspension via set of suspension hooks (standard equipment)

Connection: Screwless three-pole terminal block, maximum diameter of wires 2.5 mm²

Standard equipment: 1 pc M20 cable gland for diameter of cable 7-12 mm, 1 pc M20 sealing plug, 2 pcs suspending hook, 2 pcs rubber gasket

Calculated lifetime – LED modules: L80B10 ta40 – 75 000h
L70B10 ta40 – 110 000h

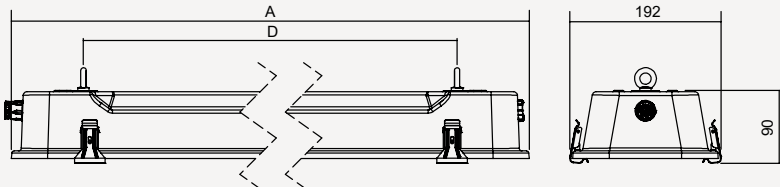

Order number	Name	Lighting fixture luminous flux (lm)	Power input (W)	Rated power output (lm/W)	Ta max (°C)	Dimensions of lighting fixture A x B x C (mm)	Mounting spacing D (mm)	Weight (kg)
variant PLUS								
053019	SALUKA-LED-PLUS-OP-2500-118-4K	2245	17	132	65	705x192x90	510	3,8
053020	SALUKA-LED-PLUS-OP-5000-218-4K	4223	33	128	60	705x192x90	510	3,9
053021	SALUKA-LED-PLUS-OP-2500-136-4K	2245	17	132	65	1305x192x90	1110	7,1
053022	SALUKA-LED-PLUS-OP-5000-236-4K	4223	33	128	60	1305x192x90	1110	7
053023	SALUKA-LED-PLUS-OP-3500-158-4K	3140	25	126	60	1605x192x90	1410	8,1
053024	SALUKA-LED-PLUS-OP-7500-258-4K	6625	47	141	65	1605x192x90	1410	8,3
053025	SALUKA-LED-PLUS-OP-9600-258-4K	7876	57	138	65	1605x192x90	1410	8,3
053017	SALUKA-LED-PLUS70-OP-5000-236-4K	4270	28	153	70	1305x192x90	1110	7
053018	SALUKA-LED-PLUS70-OP-7500-258-4K	6669	43	155	70	1605x192x90	1410	8,3
variant FROST								
054492	SALUKA-LED-FROST-OP-5000-136-4K	4382	28	157	-40	1305x192x90	1110	7,1
054493	SALUKA-LED-FROST-OP-10000-236-4K	8245	56	147	-40	1305x192x90	1110	7
054494	SALUKA-LED-FROST-OP-4750-158-4K	4255	26	164	-40	1605x192x90	1410	8,1
054495	SALUKA-LED-FROST-OP-7500-258-4K	6830	43	159	-40	1605x192x90	1410	8,3
054496	SALUKA-LED-FROST-OP-12500-258-4K	10348	69	150	-40	1605x192x90	1410	8,3

Tolerance of luminous flux and power input of the lighting fixture +/- 10%

SALUKA-LED-PLUS/FROST-OP

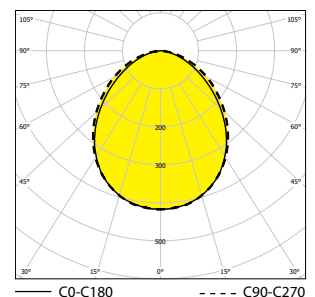

Accessories on request



051139 Set of ceiling brackets SALUKA (2 pcs)



051145 Pole bracket SALUKA stainless steel (for Ø 50 mm)

064018 Pole bracket SALUKA stainless steel (for Ø 40 mm)

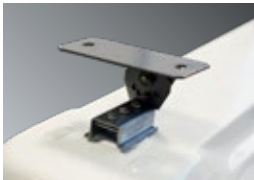

063754 Set of adjustable brackets SALUKA (2 pcs)



051147 Stainless steel wall arm bracket SALUKA 60° (1 pc)

Lighting fixture detail



On request

2.7K-6.5K - colour temperature

GESIS – possibility to equip lighting fixtures with connectors

NEREZ - housing produced from stainless steel AISI 304 or AISI 316 (in case of STAINLESS STEEL version its declared for ambient temperature decreased about 5-10°C)

DIM – dimmable electronic ballast (DALI)

1/3 F - single-phase or three phase through wiring connection, maximum diameter of wires 1.5 mm²

NANO - lighting fixtures can be protected by special nano-layer (hydrophobic, oleophobic or antibacterial protection)

Standard order number	EM-1H	EM-3H	MULTI-1H	MULTI-3H	DALI	1F	3F
variant PLUS							
053019	X	X	X	X	X	053019 1F	053019 3F
053020	X	X	X	X	X	053020 1F	053020 3F
053021	X	X	X	X	X	053021 1F	053021 3F
053022	X	X	X	X	X	053022 1F	053022 3F
053023	X	X	X	X	X	053023 1F	053023 3F
053024	X	X	X	X	X	053024 1F	053024 3F
053025	X	X	X	X	X	053025 1F	053025 3F
variant FROST							
054492	X	X	X	X	X	054492 1F	054492 3F
054493	X	X	X	X	X	054493 1F	054493 3F
054494	X	X	X	X	X	054494 1F	054494 3F
054495	X	X	X	X	X	054495 1F	054495 3F
054496	X	X	X	X	X	054496 1F	054496 3F



EXTREME-LED-PLUS/FROST

IP 66

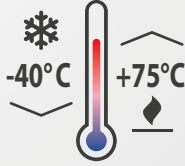

5 year warranty

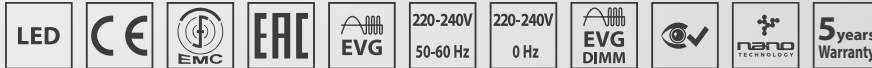

Application: Aluminium dustproof lighting fixture EXTREME-LED-PLUS/FROST with splash water resistance designed for workshops, garages, industrial and production areas with higher ambient temperature, or warehouses and freezers with low temperature.

Ballast: EP – electronic 220-240 V/50-60 Hz AC, 220-240 V DC

Light source: LED, 4000K, CRI +80, MacAdam3

Housing: Aluminium alloy with ELOX surface treatment equipped with plastic ends caps (polycarbonate)

Diffuser: OP – matt hardened safety glass

Fastening: Surface wall or ceiling mounting by means of adjustable brackets, suspension via set of cable suspenders

Connection: Screwless three-pole terminal block, maximum diameter of wires 2.5 mm²

Standard equipment: 1 pc M20 cable gland for diameter of cable 7-12 mm, 1 pc M20 sealing plug

Calculated lifetime – LED modules:

L80B10 ta40 – 75 000h

L70B10 ta40 – 110 000h

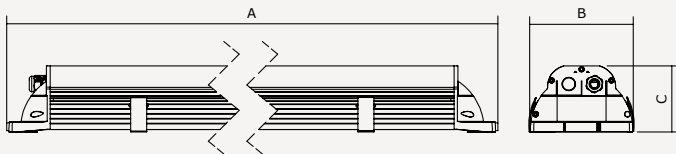

Order number	Name	Lighting fixture luminous flux (lm)	Power input (W)	Rated power output (lm/W)	Ta max (°C)	Dimensions of lighting fixture A x B x C (mm)	Weight (kg)
054465	EXTREME-LED-PLUS/FROST-OP-1R-5000-236-4K	3940	28	141	75	1320x165x105	8
054466	EXTREME-LED-PLUS/FROST-OP-2R-10000-236-4K	7881	56	141	65	1320x165x105	8
054467	EXTREME-LED-PLUS/FROST-OP-1R-4750-258-4K	3826	26	147	75	1620x165x105	10
054468	EXTREME-LED-PLUS/FROST-OP-1R-7500-258-4K	6142	43	143	70	1620x165x105	10
054469	EXTREME-LED-PLUS/FROST-OP-2R-12500-258-4K	9891	69	143	65	1620x165x105	10

Tolerance of luminous flux and power input of the lighting fixture +/- 10%

EXTREME-LED-PLUS/FROST-OP

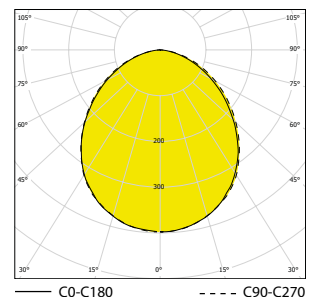

Accessories on request



008006N	Cable gland ESKV M20x1.5
008088	Ventilation plug EVPS 20, grey RAL 7035
008097	Plastic nut WISKA EMUG 20 M20x1.5

Lighting fixture detail



On request

2.7K-6.5K - colour temperature

GESIS – possibility to equip lighting fixtures with connectors

1/3 F - single-phase or three phase through wiring connection, maximum diameter of wires 2.5 mm²

DIM – dimmable electronic ballast (DALI)

NANO - lighting fixtures can be protected by special nano-layer (hydrophobic, oleophobic or antibacterial protection)

Stadard order number	EM-1H	EM-3H	MULTI-1H	MULTI-3H	DALI	1F	3F
054465	X	X	X	X	054465 DALI	054465 1F	054465 3F
054466	X	X	X	X	054466 DALI	054466 1F	054466 3F
054467	X	X	X	X	054467 DALI	054467 1F	054467 3F
054468	X	X	X	X	054468 DALI	054468 1F	054468 3F
054469	X	X	X	X	054469 DALI	054469 1F	054469 3F



PITBUL-LED-PLUS

IP 66

5 year warranty

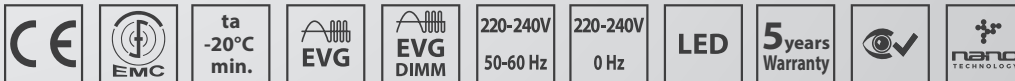
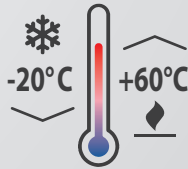

Application: Robust metal lighting fixture PITBUL-LED with high degree of protection is designed for areas, such as heavy industry, areas with occurrence of aggressive substances (e.g. oils, greases) and other manufacturing areas.

Ballast: EP – electronic 220-240 V/50-60 Hz AC, 220-240 V DC

Light source: LED, 4000K, CRI +80, MacAdam3

Housing: White painted steel sheet RAL 9003

Diffuser: CG – clear hardened safety glass
OPG – matt hardened safety glass

Reflector: White painted steel sheet RAL 9003

Fastening: Direct surface mounting by means of M8 screws, suspension via suspending brackets.

Connection: Screwless three-pole terminal block, maximum diameter of wires 2.5 mm²

Standard equipment: Cable gland Pg13.5 for diameter of cable 7-12 mm and sealing plug.

Calculated lifetime – LED modules: L80B10 ta35 – 70 000h, L70B10 ta35 – 100 000h

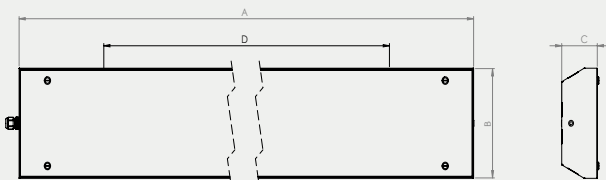

Order number	Name	Lighting fixture luminous lux (lm)	Power input (W)	Rated power output (lm/W)	Ta max (°C)	Dimensions of lighting fixture A x B x C (mm)	Mounting spacing D (mm)	Weight (kg)
051895	PITBUL-LED-PLUS-CG-4400-4K, IP66	4034	26	155	60	1250x245x100	800	11,5
051896	PITBUL-LED-PLUS-OPG-4400-4K, IP66	4090	26	157	60	1250x245x100	800	11,5
051897	PITBUL-LED-PLUS-CG-10000-4K, IP66	9414	65	145	60	1250x245x100	800	11,5
051898	PITBUL-LED-PLUS-OPG-10000-4K, IP66	9545	65	147	60	1250x245x100	800	11,5

Tolerance of luminous flux and power input of the lighting fixture +/- 10%

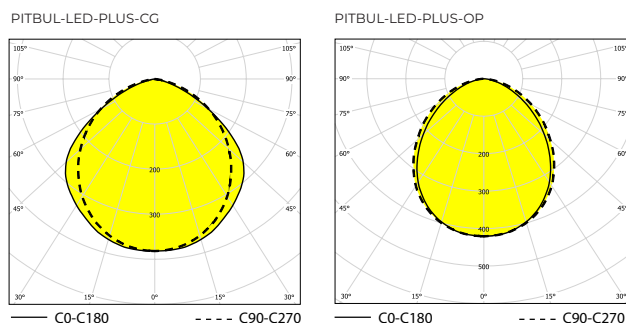

Accessories on request



Direct mounting

054935 Set of stainless steel ceiling brackets
PITBUL (2 pcs)



Suspended mounting

051146 Pole bracket PITBUL (for Ø 50 mm)



Suspended mounting

004642 Suspension bracket DIN 580 M8 PITBUL - 1 pc

Lighting fixture detail

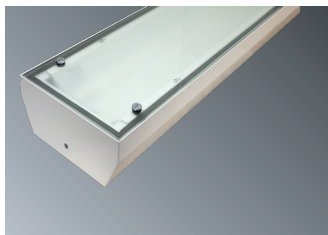

PITBUL-LED-PLUS-OPG



PITBUL-LED-PLUS-CG



GALGO-LED

IP 65

5 year warranty

ANTI-LIGATURE



IK10++ 120J



Application: Antivandal lighting fixture GALGO-LED with dust and water jets resistance is designed for areas with high risk of damage, i.e. prison cells, psychiatric hospitals, gyms and pedestrian subways.

Ballast: EP – electronic 220-240V /50-60Hz AC, 220-240V DC 0Hz

Light source: LED, 4000K, CRI +80, MacAdam3

Housing: White painted steel sheet RAL 9003

Diffuser: Extremely resistant material PC (polycarbonate)

Fastening: Surface wall or ceiling mounting

Connection: Screwless three-pole terminal block, maximum diameter of wires 2.5 mm². The lighting fixture is prepared for loop-in (possibility of connection of two cables)

Standard equipment: 2 pcs cable gland, washers with rubber to seal mounting holes, safety screws (it is necessary to order additionally 004778 - Bit for safety screw with socket head and pin s=3)

Calculated lifetime – LED modules:

L80B10 ta30 – 70 000h

L70B10 ta30 – 100 000h

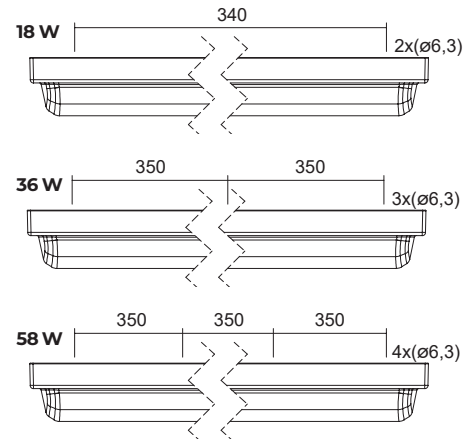
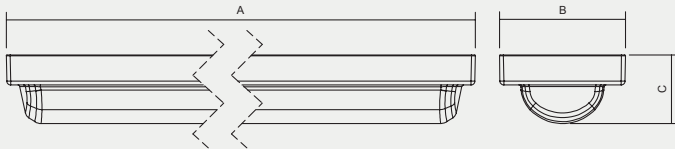

Order number	Name	Lighting fixture luminous flux(lm)	Power input (W)	Rated power output (lm/W)	Ta max (°C)	Dimensions of lighting fixture A x B x C (mm)	Weight (kg)
SYM							
051770	GALGO-LED-1250-118-4K	1110	8	139	40	690x198x108	6,3
051771	GALGO-LED-2500-218-4K	2220	16	139	40	690x198x108	5,5
051772	GALGO-LED-5000-218-4K	4650	33	141	40	690x198x108	6,3
051773	GALGO-LED-2500-136-4K	2271	17	134	60	1300x198x108	11
051774	GALGO-LED-5000-236-4K	4542	33	138	60	1300x198x108	11
051775	GALGO-LED-10000-236-4K	9300	66	141	40	1300x198x108	11
051776	GALGO-LED-3750-158-4K	3406	25	136	50	1600x198x108	13
051777	GALGO-LED-7500-258-4K	6813	50	136	50	1600x198x108	13
051778	GALGO-LED-12550-258-4K	11639	80	145	40	1600x198x108	13
ASYM							
051795	GALGO-LED-ASYM-3800-218-4K	3273	25	131	30	696x198x108	5,5
051796	GALGO-LED-ASYM-7600-236-4K	6546	49	134	30	1306x198x108	11
051797	GALGO-LED-ASYM-10500-258-4K	7637	56	137	30	1606x198x108	13

Tolerance of luminous flux and power input of the lighting fixture +/- 10%

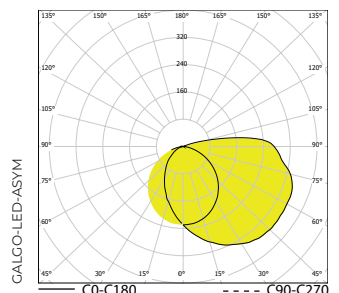
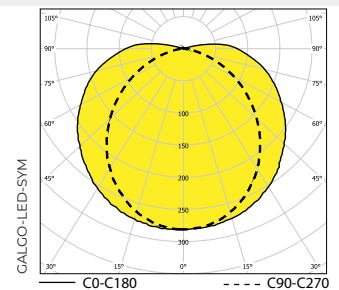

Order number	Name	Lighting fixture luminous flux(lm)	Power input (W)	Rated power output (lm/W)	Ta max (°C)	Dimensions of lighting fixture A x B x C (mm)	Weight (kg)
SYM							
051770 FF	GALGO-LED-FF-1250-118-4K	1110	8	139	40	696x198x108	6,5
051771 FF	GALGO-LED-FF-2500-218-4K	2220	16	139	40	696x198x108	5,2
051772 FF	GALGO-LED-FF-5000-218-4K	4650	33	141	40	696x198x108	6,5
051773 FF	GALGO-LED-FF-2500-136-4K	2271	17	134	60	1306x198x108	11,2
051774 FF	GALGO-LED-FF-5000-236-4K	4542	33	138	60	1306x198x108	11,2
051775 FF	GALGO-LED-FF-10000-236-4K	9300	66	141	40	1306x198x108	11,2
051776 FF	GALGO-LED-FF-3750-158-4K	3406	25	136	50	1606x198x108	13,2
051777 FF	GALGO-LED-FF-7500-258-4K	6813	50	136	50	1606x198x108	13,2
051778 FF	GALGO-LED-FF-12550-258-4K	11639	80	145	40	1606x198x108	13,2
ASYM							
051795 FF	GALGO-LED-FF-ASYM-3800-218-4K	3273	25	131	30	690x198x108	6,5
051796 FF	GALGO-LED-FF-ASYM-7600-236-4K	6546	49	134	30	1300x198x108	11,2
051797 FF	GALGO-LED-FF-ASYM-10500-258-4K	7637	56	137	30	1600x198x108	13,2

FF (full frame)

VYRTYCH antivandal luminaires with FF marking comply with ANTI LIGATURE or SUICIDE RESISTANT requirements for areas with high risk of damage like prison or a secure healthcare facility. There are generally no moving or protruding parts or rounded, bevelled corners also prevent points, where something can be attached. This means there are no ligature points or attachment areas that could enable a luminaire to be used for self-harming.

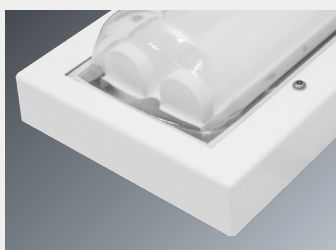

GALGO-LED-FF

This type of luminaire is equipped with a diffuser with a complete sheet metal frame.

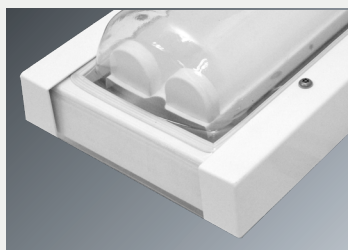

GALGO-LED

This type of luminaire is equipped with a diffuser, which is complemented on the long sides by a reinforcing sheet metal rim.

On request

Em – non-maintained emergency lighting (1h, 3h)

DIM – dimmable electronic ballast (DSI, DALI)

2.7K-6.5K – colour temperature

MULTI – maintained emergency lighting (1h, 3h)

NANO – lighting fixtures can be protected by special nano-layer (hydrophobic, oleophobic or antibacterial protection)

RAL – other colour scale

MW SENSOR - microwave sensor (if a sensor is required, contact technical support)

NEREZ - housing produced from stainless steel AISI 304 or AISI 316

(in case of STAINLESS STEEL version its declared for ambient

temperature decreased about 5-10°C)

NIGHT LIGHT - equipped with 4-8W LED source for night-time lighting

Stadard order number	MULTI-1H	MULTI-3H	DALI	1F	3F
051770	051790	X	051770 DALI	X	X
051771	051780	X	051771 DALI	X	X
051772	X	X	051772 DALI	X	X
051773	051791	051793	051773 DALI	X	X
051774	051781	051784	051774 DALI	X	X
051775	X	X	051775 DALI	X	X
051776	051792	051794	051776 DALI	X	X
051777	051782	051785	051777 DALI	X	X
051778	X	X	051778 DALI	X	X

Stadard order number	MULTI-1H	MULTI-3H	DALI	1F	3F
051770 FF	X	X	051770 FF DALI	X	X
051771 FF	051780 FF	051783 FF	051771 FF DALI	X	X
051772 FF	X	X	051772 FF DALI	X	X
051773 FF	X	X	051773 FF DALI	X	X
051774 FF	051781 FF	051784 FF	051774 FF DALI	X	X
051775 FF	X	X	051775 FF DALI	X	X
051776 FF	X	X	051776 FF DALI	X	X
051777 FF	051782 FF	051785 FF	051777 FF DALI	X	X
051778 FF	X	X	051778 FF DALI	X	X

STL INTERNATIONAL LTD

Hill Farm, Linton Hill
Maidstone, Kent, ME17 4AL
United Kingdom

t. +44 (0)1622 749633
e. solutions@stl-int.co.uk
www.stl-int.co.uk

Scan me to explore
our product range

